

GRILLE OFF

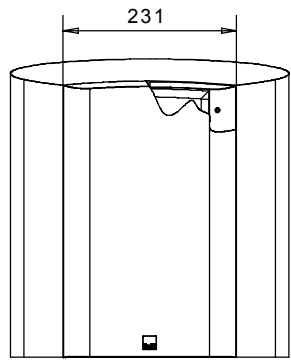

GRILLE ON

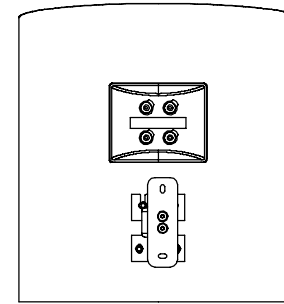
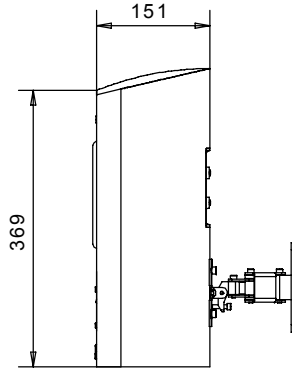
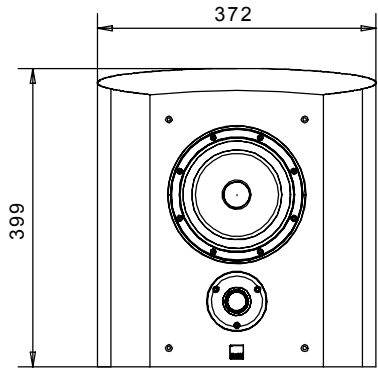
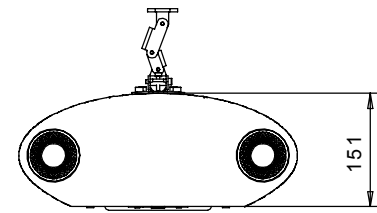
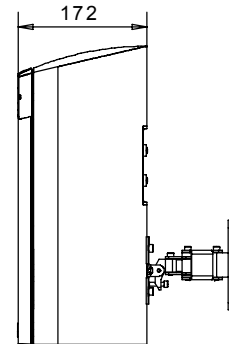
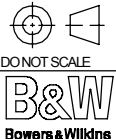

 <p>B&W Bowers & Wilkins</p>	<p>DIMENSIONS IN mm</p> <p>TOLERANCES</p> <p>0. ± 0.5</p> <p>0.0 ± 0.3</p> <p>0.00 ± 0.1</p> <p>ANGLES ± 0.5°</p> <p>UNLESS OTHERWISE STATED</p>	<p>MATERIAL</p> <p>FINISH</p>					<p>COPYRIGHT © 2004</p>		<p>PART NO.</p> <p>FP22268</p>	
			<p>3 REDRAWN</p>		<p>22.6.05</p>		<p>CHECKED / APPROVED</p>		<p>DRG. NO.</p> <p>A7116-1-1</p>	
			<p>ISS</p>	<p>AMENDMENT</p>	<p>ECN NO.</p>	<p>DATE</p>	<p>APPROVAL</p>	<p>SCALE</p> <p>NTS</p>	<p>DATE</p> <p>15.10.04</p>	<p>ISS</p>
			<p>TITLE</p> <p>SCMS LINE DRAWING</p>				<p>FULL DRG SIZE</p> <p>A3</p>		<p>ISS</p> <p>3</p>	