

CLASSÉ AUDIO

C-501

REMOTE CONTROL
BALANCED PREAMPLIFIER

C-501

OWNER'S MANUAL

CLASSÉ DESIGN PHILOSOPHY

1. REPEATED LISTENING DESIGN SESSIONS:

Fine tuning of sound by exchanging and mixing of parts (transistors, capacitors, wiring, PCB boards etc.), and adjusting many specific operating voltages within proper engineering ranges, producing an overall sonic recipe giving the most natural harmonic realism of music typical of instruments in a live performance.

2. UPGRADABLE SINGLE CIRCUIT DESIGNS:

All Classé products (all preamps and all amps) share exactly the same circuit design philosophy (excluding moving coil and moving magnet phono circuits). This means all amplifiers and all high level circuits of the preamps benefit from the same design goals. Similar circuits are then tailored to different power levels etc. Differences between less expensive models and more expensive models are parts quality and compliment, power supply extravagance and the amount of filtering etc., as well as features and packaging.

This means that for years Classé has been constantly sonically fine tuning and technically upgrading this circuit design and its application, thus reaching a very high level of natural musical enjoyment, as well as excellent reliability which benefits all models - least expensive, most expensive, preamps and amplifiers alike.

3. EXTREME LONG LIFE IN REAL WORLD CONDITIONS:

Choosing the best attainable quality parts and materials combined with the advantages of the two above-mentioned areas provides Classé owners with years of proven trouble free reliability and musical enjoyment.

C-501
OWNER'S MANUAL

TABLE OF CONTENTS

UNPACKING & SET-UP.....	4
A.C. LINE POWER.....	5
INPUTS.....	6
OUTPUTS	8
FRONT PANEL CONTROLS.....	9
FEATURES AND SPECIFICATIONS	18

UNPACKING & SET-UP

Your new preamplifier has been carefully wrapped in heavy gauge plastic, packed in semi-rigid foam and contained in a special box. To remove the unit, open and spread the top flaps of the box. By its sides, lift out the entire unit with the foam pieces intact. Remove each foam side by pulling straight out. Remove the plastic wrap and inspect the unit for any concealed damage. Apart from this owner's manual, please ensure the following has also been included:

- 1) Detachable A.C. linecord.
- 2) 5/64 in. Allen key for top cover
- 3) Remote Control unit (Allen key and Batteries AAA X 2 included).

Please report any damage or missing parts to your dealer promptly.

This preamplifier, being capable of very high gain, must be located in a position free of any hum-inducing magnetic fields. (This also applies to turntables and interconnect cables.) Positions adjacent to power amplifiers, A.C. line filters, or regulation devices should be avoided. Ideally, a few feet should separate the preamplifier from the power amplifier. As well, keep low-level interconnect cables away from the power amp and separate from A.C. linecords.

Heat generated by the preamplifier is negligible. Air space around the unit need not be a concern.

Check the Serial Number sticker on the back of the unit for the correct operating voltage. Regardless of voltage, the fuse rating should be 2 AMP SLO-BLO.

A.C. LINE POWER

The preamplifier has no power switch. Its low power consumption and improved sonics from always being ON led to the omission of an ON/OFF switch. In fact, while thoroughly musical shortly after turn-on, the preamplifier will exhibit "sonic growth" for the first 300 hours of used.

For optimum sonic performance, you should consider use of the optional CLASSE REFERENCE A.C. LINECORD. Consult your dealer regarding this accessory.

SAFETY FEATURE: The preamplifier is designed with an Auto-Muting Circuit which engages and is indicated by two FLASHING RED ARROWS when the unit is first connected, or after an A.C. power failure. After 45 seconds of stabilizing the preamplifier is automatically switched to "MUTE" mode, after which all operating functions such as input etc. may then be selected.

CAUTION: "FLOATING THE GROUND" OR DEFEATING THE GROUND ON A 3-PRONG LINECORD MAY CREATE A SHOCK HAZARD. CONNECT ALL INTERCONNECT CABLES BETWEEN THE ELECTRONICS BEFORE CONNECTING THE A.C. LINECORDS TO THE WALL OUTLETS. THIS WILL REDUCE THE POTENTIAL SHOCK HAZARD. SEE ALSO THE WARRANTY SECTION OF THIS OWNER'S MANUAL.

INPUTS

The input jacks are clearly marked on the back of the C-501. The following inputs are provided: BAL 1, BAL 2, REG 1 (also used for Phono), REG 2, REG 3, REG 4, TAPE, and a SURROUND sound loop. (see figure 3).

OPTIONAL INTERNAL PHONO FEATURE:

The REG 1 input jacks are to be used with the optional phono feature (see fig.6) The phono ground screw is located between the REG 4 and TAPE IN jacks. The optional phono can accommodate both magnetic and moving coil cartridges of various outputs. In the MC position, gain of the Moving Coil stage is factory preset at 16dB which matches perfectly with most typical MC cartridges. With the resistor kit included with the optional phono feature, the gain can also be adjusted to 20db, 25db, or 30db in order to optimize system gain, and lower noise while using other less typical MC cartridges. (Note: The MC gain is in addition to the standard MM gain of 42dB). To change the MC gain, proceed as follows:

1. Disconnect A.C. linecord from the wall outlet.
2. Remove top cover with Allen key supplied.
3. Locate R245 and R145 (see fig.6), which are the MC gain setting resistors for the LEFT and RIGHT channel respectively. Remove the resistors and replace them with newly selected ones, according to the following chart.

	GAIN	COLOR CODED RESISTOR	(or) NUMERICAL RESISTOR
Standard:	16db	(Brown, Brown, Black, Black)	1100 (110 ohms)
	20db	(Red, Black, Black, Black)	2000 (200 ohms)
	25db	(Orange, Grey, Orange, Black)	3830 (383 ohms)
	30db	(Violet, Blue, Grey, Black)	7680 (768 ohms)

4. Having completed the resistor changes, replace the top cover.

BALANCED, TAPE, AND REGULAR INPUTS

The BALANCED INPUTS are true differential high level inputs, wired as follows:

PIN 1: GROUND

PIN 2: POSITIVE (NON-INVERTED) SIGNAL

PIN 3: NEGATIVE (INVERTED) SIGNAL

The Balanced inputs may be used with CD players that have a balance output, or any other high level, balanced source.

The TAPE IN of the C-501 should be connected to the LINE OUT or TAPE OUT of the tape deck. (See FRONT PANEL CONTROLS: TAPE SWITCH.)

The Regular inputs may be used with any high level sources (REG 1 may also be used with the optional Classé Internal Phono Feature.)

OUTPUTS

The C-501 has both regular (single-ended) and balanced outputs. Both are working at all times, and may be used separately, or simultaneously.

TAPE OUTPUT

Whichever input is selected will be fed to the TAPE OUTPUT jacks. This should be connected to the TAPE IN or LINE IN of the tape deck.

REGULAR OUTPUTS

Simply connect your regular interconnects to the RCA output jacks marked REGULAR OUT on the back of the C-501.

BALANCED OUTPUTS

A balanced power amplifier and balanced interconnects are also required. For use with balanced power amplifiers other than Classé, the wiring of the 3-pin XLR connectors must be wired as follows:

PIN 1: GROUND

PIN 2: POSITIVE (NON-INVERTED) SIGNAL

PIN 3: NEGATIVE (INVERTED) SIGNAL

If the pin configuration of the power amplifier differs from above, the balanced interconnects must be modified to accommodate the different power amp.

Having confirmed the correct connections, plug the XLR connectors of the balanced interconnects into the locking XLR connectors on the rear panel of the C-501 marked BALANCED OUT. (To remove the connectors, press the tab above the connector.)

FRONT PANEL CONTROLS

NOTE: All functions (except Display, Gain, and Phase) may be activated directly on the front panel, or otherwise by the hand held remote control.

DISPLAY:

Three (3) different display brightness levels can be selected (Full/Medium/Low as well as Off).

NOTE: *With display set at the OFF position, activating any switches on the front panel or from the remote control unit will temporarily turn the display to ON at full brightness. The display will automatically turn back to OFF after approximately 10 seconds from the last change.*

GAIN:

The dual gain feature provides the user to set the preamplifier either at REGULAR gain of 18db or LOW gain of 12db. The red indicator "GAIN" appears in the display when LOW gain is selected.

PHASE:

Phase of the output signal can be switched between inverted (180 degrees phase shift) or normal non-inverted (0 degree phase shift). The red indicator "PHASE" is shown when the unit is in the inverted mode.

TAPE

The TAPE button selects the input signal, between the TAPE and SOURCE inputs, which goes to the main REGULAR and BALANCED output jacks. The red indicator "TAPE" appears when Tape input is selected. However, the SOURCE signal always appears at the TAPE OUT jacks and shown in the display.

SURROUND

When the surround mode is engaged, the selected signal is directed to the SURROUND output connectors where it is sent to a Surround Sound Processor for the decoding process. The Front-Left and Front-Right output signals from the Surround sound processor are then fed to the Left and Right Surround input connectors on the back of the preamplifier. The main outputs of the preamplifier (both Balanced or Regular) are now to be connected to the amplifier powering the Front-left and Front-right speakers of your surround sound system. (see figure 4)

All preamplifier functions (except input select, display, and mute) are disabled in the surround mode.

SAFETY FEATURE: The volume control of the preamplifier is automatically brought back to the MIN position, and MUTE is also engaged when the preamplifier is switched back from the surround mode to the regular stereo mode.

VOLUME CONTROL

The preamplifier volume control has a total of 60 steps of level adjustments which varies the level of both channels simultaneously. The volume can be operated from the remote using the hand held control unit or manually turning the control knob at the preamplifier.

The volume will turn up or down ONE step at a time when the buttons are pressed intermittently. When the buttons are pressed and held constantly the volume will change rapidly until the pressed volume button is released.

BALANCE CONTROL (remote control unit)

The custom BALANCE control permits equal output of each channel in the centre position (00 will be displayed) without additional loading to the signal. When shifted to the left or right, it merely attenuates the opposite channel.

The balance control has 15 steps of adjustments for each direction (indicated by the arrows). The balance position will be shown only when the balance button is pressed. Similar to the volume operation, the balance will move one step each time the buttons are pressed intermittently. When the buttons are pressed and held constantly the balance will change rapidly until the pressed button is released.

Current balance position may be viewed by pressing either one of the balance buttons once. Volume position will resume approximately 10 seconds after the last change of balance or activating any other functions.

MUTE SWITCH

Switching between PLAY and MUTE can be done by either pressing the mute button on the front panel of the preamplifier or on the remote control unit. The green indicator "MUTE" is shown in the display when mute is engaged.

NOTE: *when the preamp is in the mute position, and the volume control is turned up either manually on the faceplate or from the remote control, the play mode is automatically selected.*

As a feature to extend the display's life span, it will automatically turn OFF if the unit is left Muted for more than one hour. Any change in the unit setting will temporarily turn the display back to ON unless the PLAY mode resumes, otherwise the display will turn to OFF again after one hour from the last change.

Caution: make sure the MUTE is ON when making or changing any connections to the preamp. This includes all inputs and outputs, as well as the A.C. linecord.

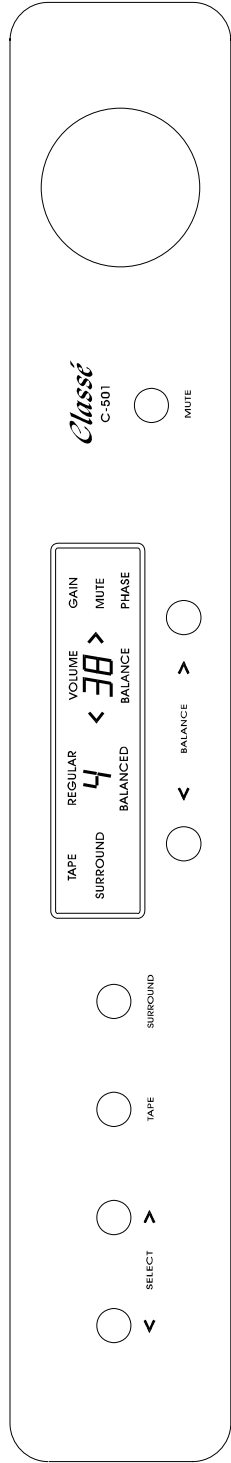

Fig.1: C-501 Front panel control

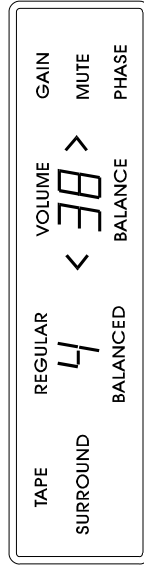

Fig.2: Display information

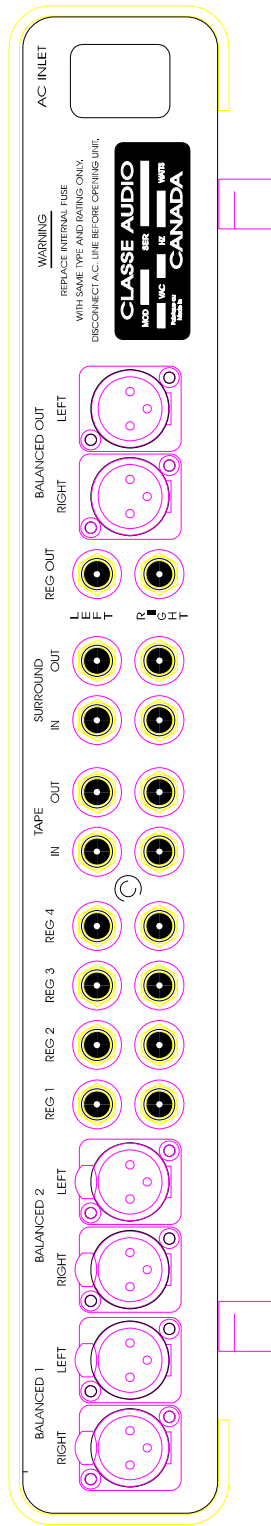

Fig.3: C-501 rear view

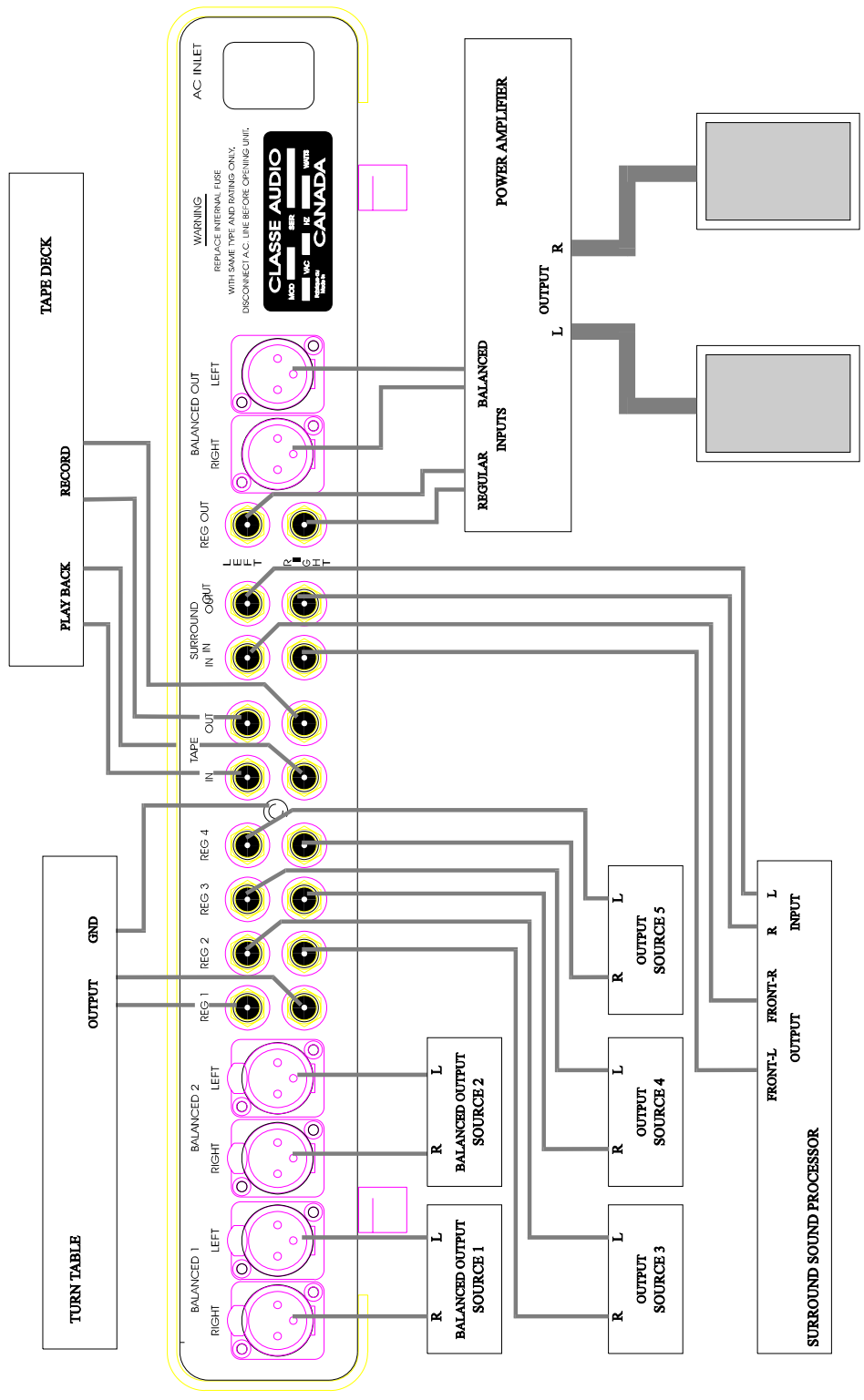

Fig.4: C-501 Typical connection

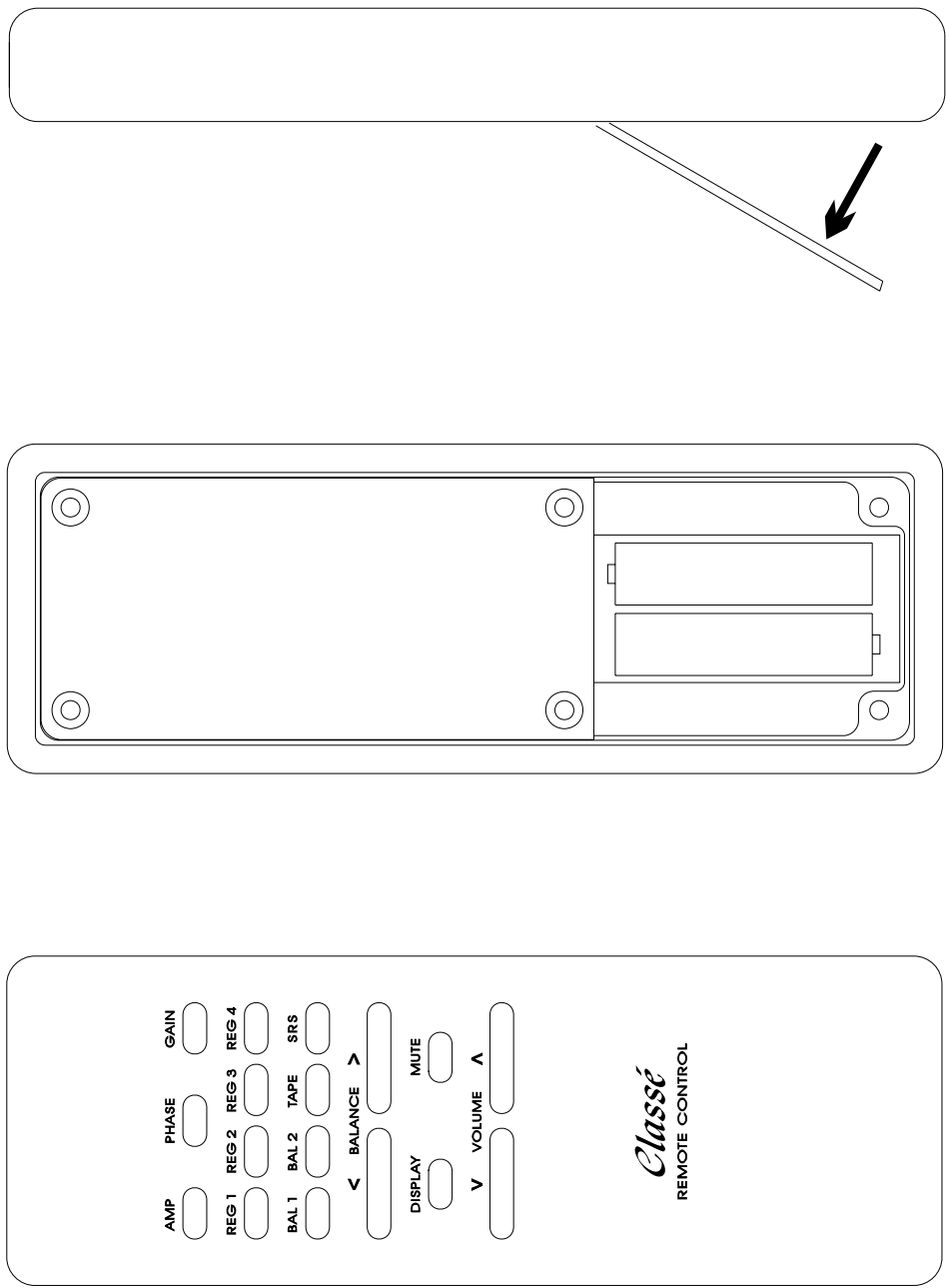

FIG.5: Remote control unit

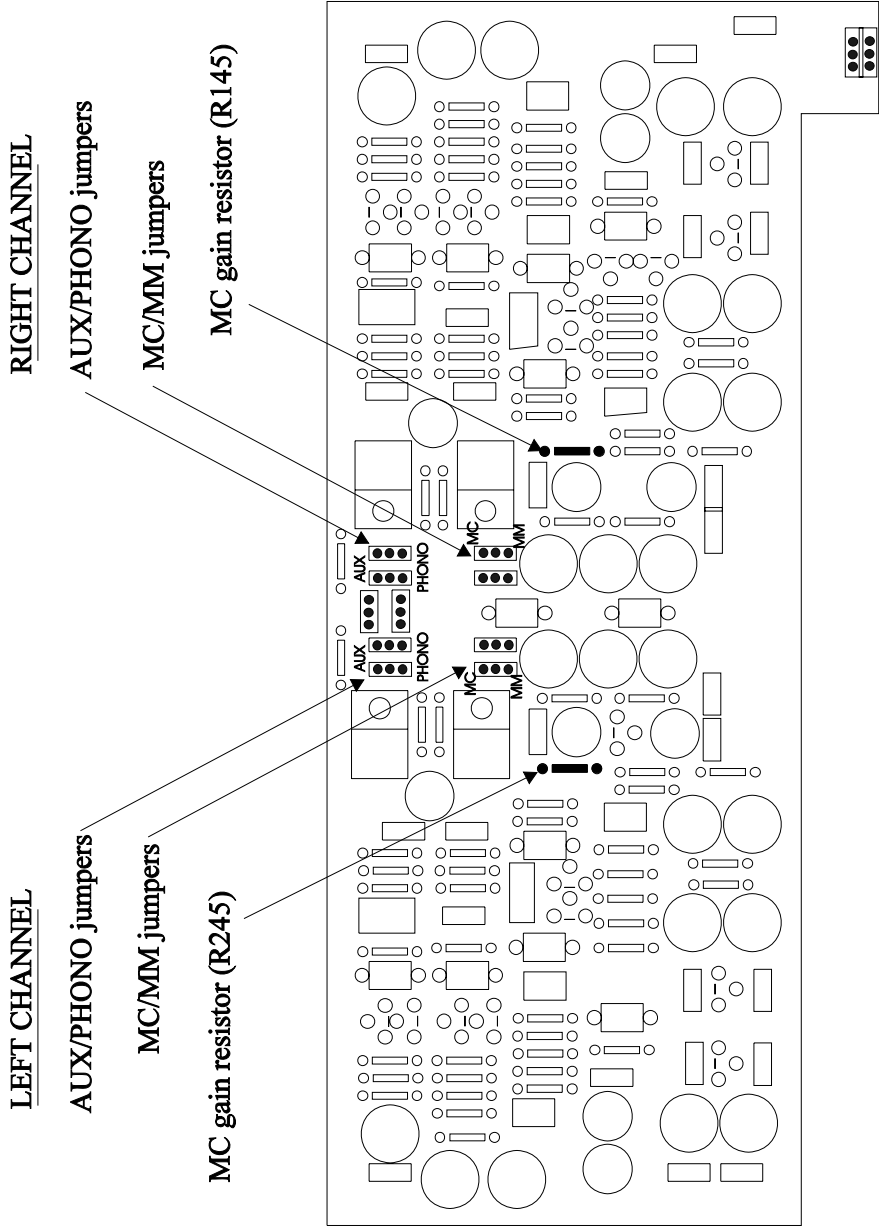
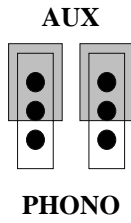
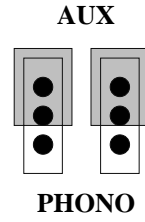

Fig.6: Jumpers and MC gain resistors locations

LEFT CHANNEL



RIGHT CHANNEL



JUMPER SETTING FOR AUX SELECTION

LEFT CHANNEL

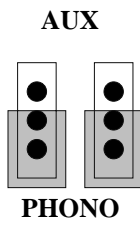

RIGHT CHANNEL

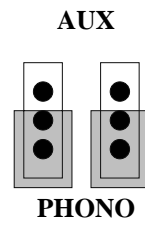

JUMPER SETTING FOR PHONO SELECTION

LEFT CHANNEL

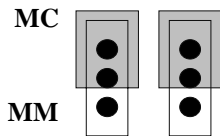

RIGHT CHANNEL

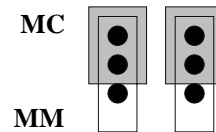

PHONO JUMPER SETTING FOR MOVING COIL (MC)

LEFT CHANNEL

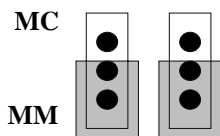

RIGHT CHANNEL

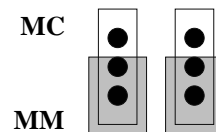

PHONO JUMPER SETTING FOR MOVING MAGNET (MM)

CLASSÉ C-501

REMOTE CONTROL BALANCED PREAMPLIFIER

FEATURES AND SPECIFICATIONS SHEET

C-501 FEATURES:

Large, regulated power supply, 2 balanced inputs, balanced outputs, regular outputs, 4 regular inputs, tape and surround sound inputs. Remote control featuring selectable inputs, phase, dual gain settings, volume, balance, mute and bright/dim display. Special Classé front panel in Soft Shadow Silver finish with brushed and anodized top cover.

C-501 SPECIFICATIONS:

Frequency Response:		20 Hz to 20 KHz +/- 0.01dB 1 Hz to 200 KHz, -1 dB
Maximum Output:		42 Volts
Sensitivity:	Line:	120 mV
	Magnetic Phono:	3 mV (opt. phono)
	Moving Coil Phono:	0.2 mV (opt. phono)
S/N Ratio ('A' Weighted):	Line:	100 dB
	Magnetic Phono:	90 dB (opt. phono)
	Moving coil Phono:	90 dB (opt. phono)
Input Impedance:		50 KOhms
Output Impedance:		Less than 50 Ohms
Phase:		0/180 degrees selectable
Gain:	Line:	18dB/12dB selectable
	Magnetic Phono:	42 dB (opt. phono)
	Moving Coil Phono:	Standard 16dB (opt phono) Adjustable 20, 25, 30dB
Power Requirement:		50 Watts
Dimensions:	Gross:	22" x 19 1/2" x 12"
	Net:	19" x 14 3/4" x 3 1/4"
Weight:	Gross:	25 lbs
	Net:	20 lbs

CLASSÉ AUDIO

5070 Francois-Cusson
Lachine, Quebec
Canada H8T 1B3

Telephone: 514 636 63 85
Fax: 514 636 14 28



Notice to all Classé Product owners:

Thank you for your purchase of a Classé Audio component.

All of us at Classé have taken extreme care to ensure that your purchase will become a prized investment. We are proud to inform you that all Classé Audio components have been officially approved for the European Community CE mark.

This means that your Classé product has been subjected to the most rigorous manufacturing and safety tests in the world, and have proven to meet or exceed all European Community CE requirements for unit to unit consistency and consumer safety.

All of us at Classé Audio wish you many years of musical enjoyment.

As of July 18, 1996, Classé Audio has been granted Certificate No: C401CLA1.MGS, which indicates CE approval for all models of the Classé Audio product line.

CLASSÉ C-501 LIMITED FACTORY WARRANTY (North America only).

IMPORTANT: WARRANTY REGISTRATION, AND A COPY OF THE "AUTHORIZED DEALER BILL OF SALE", MUST BE RECEIVED AT THE CLASSÉ FACTORY (address below) WITHIN TWENTY (20) DAYS OF PURCHASE BY THE FIRST RETAIL PURCHASER IN ORDER TO VALIDATE THESE WARRANTIES.

FIVE YEAR WARRANTY (ALL PARTIES)

Classé Audio Inc. warrants this preamplifier to be free from defects in materials and workmanship for a period of **FIVE YEARS** from date of manufacture provided that any claim in virtue of this warranty be made in writing within such period. (Hand held remote control 1 year only. No warranty for batteries).

LIFETIME WARRANTY (FIRST RETAIL PURCHASER ONLY)

Subject to all of the conditions stated herein, **A LIMITED NON-TRANSFERABLE FACTORY LIFETIME WARRANTY IS EXTENDED ONLY TO THE ORIGINAL OWNER WHO FIRST PURCHASED THE PREAMPLIFIER IN NORTH AMERICA AT RETAIL AND WHO CLAIMS UNDER THIS WARRANTY IN NORTH AMERICA** (not applicable to hand held remote control and batteries). This Lifetime warranty terminates when this preamplifier is sold by such First Retail Purchaser to a Third Party.

"THIS LIFETIME WARRANTY DOES NOT EXTEND TO THE DIGITAL CIRCUITRY CONTAINED IN THE UNIT, BUT SUCH DIGITAL CIRCUITRY IS SUBJECT TO THE FIVE (5) YEAR WARRANTY REFERRED TO ABOVE."

In the event of failure of this preamplifier, Classé Audio Inc., will repair, recalibrate, or at its discretion, replace the unit in accordance with these Warranties providing that all the conditions contained in these warranties are met.

In order to initiate service of any kind, it is necessary to **OBTAIN PRIOR FACTORY AUTHORIZATION, AND SHIP THE UNIT PREPAID**. For units coming from outside Canada, contact the factory for our forwarding address. Units shipped directly to our Canadian address from outside the country will be stopped at the border, causing extensive delays or return of the unit to the sender.

The warranty shall be void and of no effect in the event of any of the following:

- 1) Operation not in accordance with this manual.
- 2) Accident, abuse, tampering, or unauthorized modification, as determined by Classé Audio Inc.

- 3) Failure to meet any of the above conditions.
- 4) Removal, defacing, or falsifying the serial number plate.
- 5) Shipping without the complete factory packaging.
- 6) Transfer or sale of this preamplifier by the original owner.
- 7) Non-compliance with any of the other conditions hereof.

CLASSÉ AUDIO INC. SHALL NOT BE LIABLE FOR ANY SPECIAL, INCIDENTAL, OR CONSEQUENTIAL DAMAGES REGARDING THE SET-UP, OPERATION, FAILURE, TROUBLESHOOTING, OR REPAIR OF THE PREAMPLIFIER AND/OR ANY OTHER EQUIPMENT USED THEREWITH.

THIS WARRANTY, ALL CLAIMS MADE IN VIRTUE HEREOF, AND ALL ISSUES RELATING TO ANY SUCH CLAIM SHALL BE GOVERNED BY THE LAWS OF THE PROVINCE OF QUÉBEC.

WARRANTY REGISTRATION

You must fill out and return the form below, along with a copy of the authorized dealer bill of sale, to the factory within twenty (20) days of purchase. This will allow us to provide expedient service, information regarding updates and new products, and validate the Classé warranty.



C-501 SERIAL NUMBER _____ PURCHASE DATE _____

AUTHORIZED DEALER _____

PURCHASER'S NAME _____

STREET ADDRESS _____

CITY _____ STATE/PROV. _____

COUNTRY _____ ZIP/POSTAL CODE _____

I BECAME AWARE OF THIS PRODUCT BY: _____

(DEALER, MAGAZINE, FRIEND, ETC.)



SEND TO: CLASSÉ AUDIO INC.

Product Registration

5070 François Cusson

Lachine, Quebec, Canada

H8T 1B3