

# CLASSE

Owner's Manual  
CP-700  
Preamplifier

**WARNING: TO REDUCE THE RISK OF FIRE OR ELECTRIC SHOCK,  
DO NOT EXPOSE THIS APPLIANCE TO RAIN OR MOISTURE.**

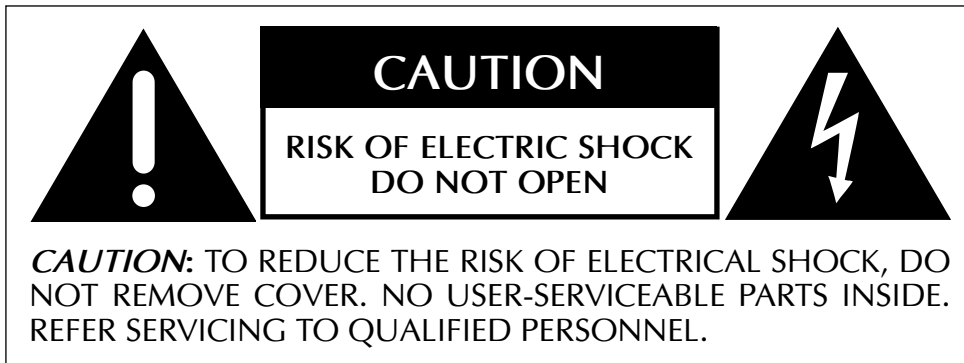

---

**NOTICE**

All of us at Classé take extreme care to ensure that your purchase will remain a prized investment. We are proud to inform you that all Classé components have been officially approved for the European Community (CE) mark.

This means that your Classé product was subjected to the most rigorous manufacturing and safety tests in the world. The CE mark certifies that your purchase meets or exceeds all European Community requirements for unit-to-unit consistency and consumer safety.

This equipment has been tested and found to comply with the limits for a Class B digital device, pursuant to Part 15 of the FCC Rules. These limits are designed to provide reasonable protection against harmful interference in a residential installation. This equipment generates, uses and can radiate radio frequency energy and, if not installed and used in accordance with the instructions, may cause harmful interference to radio communications. However, there is no guarantee that interference will not occur in a particular installation. If this equipment does cause interference to radio or television reception, which can be determined by turning the equipment on and off, the user is encouraged to try to correct the interference by one or more of the following measures:

- Reorient or relocate the receiving antenna;
- Increase the separation between the equipment and the receiver;
- Connect the equipment into an outlet on a circuit different from that to which the receiver is connected;
- Consult the dealer or an experienced radio/TV technician for help.

**CAUTION:** Changes or modifications to this equipment not expressly approved by the manufacturer could void the user's authority to operate the equipment.

This product incorporates copyright protection technology that is protected by U.S. patents and other intellectual property rights. Use of this copyright protection technology must be authorized by Macrovision, and is intended for home and other limited viewing uses otherwise authorized by Macrovision. Reverse engineering or disassembly is prohibited.

The information contained in the manual is subject to change without notice. The most current version of this manual will be posted on our web site at <http://www.classeaudio.com>.



Marking by the "CE" symbol (shown left) indicates compliance of this device with the EMC (Electromagnetic Compatibility) and LVD (Low Voltage Directive) standards of the European Community.



Classé products are designed to comply with international directives on the Restriction of Hazardous Substances (RoHS) in electrical and electronic equipment and the disposal of Waste Electrical and Electronic Equipment (WEEE). The crossed wheeled bin symbol indicates compliance and that the products must be appropriately recycled or processed in accordance with these directives.

This device complies with part 15 of the FCC Rules. Operation is subject to the following two conditions: (1) This device may not cause harmful interference, and (2) This device must accept any interference received, including interference that may cause undesired operation.

**Please record the serial number for your new Classé component here for future reference.**

**Serial #:** \_\_\_\_\_

# Important Safety Instructions

1. Read these instructions.
2. Keep these instructions.
3. Heed all warnings.
4. Follow all instructions.
5. Do not use this apparatus near water.
6. Clean only with dry cloth.
7. Do not block any ventilation openings. Install in accordance with the manufacturer's instructions.
8. Do not install near any heat sources such as radiators, heat registers, stoves, or other apparatus (including amplifiers) that produce heat.
9. Do not defeat the safety purpose of the polarized or grounding-type plug. A polarized plug has two blades with one wider than the other. A grounding type plug has two blades and a third grounding prong. The wide blade or the third prong are provided for your safety. If the provided plug does not fit into your outlet, consult an electrician for replacement of the obsolete outlet.
10. Protect the power cord from being walked on or pinched particularly at plugs, convenience receptacles, and the point where they exit from the apparatus.
11. Only use attachments/accessories specified by the manufacturer.
12.  Use only with the cart, stand, tripod, bracket, or table specified by the manufacturer, or sold with the apparatus. When a cart is used, use caution when moving the cart/apparatus combination to avoid injury from tip-over.
13. Unplug this apparatus during lightning storms or when unused for long periods of time.
14. Refer all servicing to qualified service personnel. Servicing is required when the apparatus has been damaged in any way, such as power-supply cord or plug is damaged, liquid has been spilled or objects have fallen into the apparatus, the apparatus has been exposed to rain or moisture, does not operate normally, or has been dropped.
15. Do not expose this apparatus to dripping or splashing and ensure that no objects filled with liquids, such as vases, are placed on the apparatus.
16. To completely disconnect this apparatus from the AC Mains, disconnect the power supply cord plug from the AC receptacle.
17. The mains plug of the power supply cord shall remain readily operable.
18. Do not expose batteries to excessive heat such as sunshine, fire or the like.



The lightning flash with arrowhead symbol within an equilateral triangle is intended to alert the user to the presence of uninsulated "dangerous voltage" within the product's enclosure that may be of sufficient magnitude to constitute a risk of electric shock to persons.



The exclamation point within an equilateral triangle is intended to alert the user to the presence of important operating and maintenance (servicing) instructions in the literature accompanying the product.

**WARNING:** To reduce the risk of fire or electric shock, do not expose this apparatus to rain or moisture.

# Contents

Welcome to the Classé family .....	6
a word about installation .....	6
Unpacking and Placement .....	7
unpacking your preamplifier .....	7
placement .....	7
ventilation .....	7
custom installations .....	7
serial number .....	7
register your purchase! .....	8
operating voltage .....	8
warm up/break-in period .....	9
please read this manual .....	9
Special Design Features .....	10
flexible graphical user interface .....	10
customizable volume control .....	10
highly refined circuit design .....	10
extensive listening tests .....	11
extraordinary longevity .....	11
robust, isolated power supply .....	11
Front Panel .....	12
Rear Panel .....	15
optional phono preamp .....	15
The Remote Control .....	20
The Menu System .....	22
operational menu .....	22
input selection .....	22
tape loop .....	22
main menu system .....	23
system setup .....	23
volume .....	24
rotary .....	24
max volume .....	26
startup volume .....	26
mute setup .....	27
input .....	27
phono gain .....	29
triggers .....	29
teach IR .....	29
display setup .....	30
brightness .....	30
timeout .....	30
language .....	31
main balance .....	31
remote Fkeys .....	31
cautionary note on Fkey use .....	32
status .....	32
version info .....	32
sensors .....	32

CAN-Bus .....	33
features .....	33
hardware setup .....	33
using CAN-Bus.....	34
CAN-Bus shared features.....	35
configuration.....	35
operate.....	35
AC status.....	35
status.....	35
name.....	35
global brightness.....	36
global standby .....	36
CAN-Bus model specific features .....	36
PlayLink .....	36
amp info .....	37
event log.....	37
Troubleshooting .....	38
Care & Maintenance .....	41
cleaning the cabinet .....	41
cleaning the LCD touchscreen.....	41
installing the remote control batteries.....	41
Specifications.....	42
Dimensions.....	43

# Welcome to the Classé family

Congratulations on your purchase of a Classé product. It is the result of many years of continuous refinement, and we are sure that you will enjoy it for many years to come.

We value our relationship with our customers. Please allow us to stay in touch with you by returning your warranty card now, before you pack up the shipping carton of your new product and forget all about it. Doing so will enable us to let you know about any possible future upgrades or updates that might become available for your Classé component.

Sending in your warranty card also registers your product with us so that warranty service can be obtained easily and quickly, even if you have mislaid your original sales slip.

---

**Please, take a few minutes to fill out the warranty registration card, and drop it in the mail.**

---

You will find the warranty registration card at the end of the separate warranty policy booklet, enclosed.

## a word about installation

Every effort has been made to make the Classé CP-700 simple and straightforward to install and use.

Still, we have no way to evaluate many other variables such as the size and shape of your room, its acoustics, and the associated equipment you have chosen to use with your preamplifier. All of these factors influence the ultimate performance of your system.

---

**For this reason, we strongly encourage you to have your system installed and calibrated by your dealer, whose experience, training, and specialized equipment can make a profound difference in the final performance of the system.**

---

# Unpacking and Placement

## unpacking your preamplifier

Carefully unpack your preamplifier according to the supplied instructions, and remove all accessories from the carton.



### Important!

---

**Keep all packing materials for future transport of your Classé product. Shipping your new component in anything other than its purpose-designed packing material may result in damage that is not covered by the warranty.**

---

## placement

As with any preamplifier, it is best to place the CP-700 centrally within your system, since it is the hub to which all other components are connected. It should also be located at a convenient height for both visibility and use, since you generally interact with your preamplifier more than any other component (changing inputs, adjusting volume, etc.).

*Note that adequate clearance for the AC cord and connecting cables must be left behind the CP-700. We suggest leaving eight inches (20 cm) of free space behind your preamplifier to allow all cables sufficient room to bend without crimping or undue strain.*

Classé recommends that the unit not be placed directly on the top surface of a power amplifier (or any other heat source).

## ventilation

Your Classé preamplifier generates a certain amount of heat in the course of normal operation. Be sure to allow three inches of clearance above it and three inches to each side to allow heat dissipation through air circulation. Avoid placement on soft surfaces that would restrict airflow (such as plush carpeting).

## custom installations

Drawings are included in this manual to facilitate special installations and custom cabinetry (see the section *Dimensions*). An optional, purpose-designed rack mount kit is available for this product. Contact your Classé dealer for more information.

## serial number

The serial number for your preamplifier is found on the rear of the unit. Please note and record this number on the page entitled *Important Safety Instructions* for your future reference.

## register your purchase!

Having found the serial number, now would be a good time to fill out the registration card. Please register your purchase so we can advise you of updates and other items of interest.

It will take only a minute or so. Please complete the card now, before you forget.

## operating voltage

The CP-700 preamplifier is set at the factory for 100V, 120V, 220V, 230V, or 240V AC mains operation, as appropriate for the country in which it is to be sold (*230V only in European Union countries, in compliance with CE regulations*). The voltage setting may not be changed by the user.

Make sure that the label on the rear panel of your preamplifier indicates the correct AC operating voltage for your location. Attempting to operate your preamplifier at an incorrect voltage may damage the unit.



### Warning:

---

**The voltage setting of your preamplifier may not be changed by the user. There are no user-serviceable parts within the unit. Please refer any problems to an authorized Classé service center.**

---

If the AC mains voltage indicated on your preamplifier is incorrect, please contact your local, authorized Classé dealer or distributor.

The CP-700 can easily be powered by a normal 15-ampere AC mains line. If other devices are also powered from the same AC line, their additional power consumption should be taken into account.

The CP-700 includes protection circuitry that will prevent the preamplifier from operating at dangerously high or low voltages.

- **At startup:** the AC mains voltage must be within a range of approximately -15% to +10% of its nominal value at startup, or the preamplifier will not turn on. For example, a 120V unit requires the AC mains to be between approximately 95V–135V in order to turn on.
- **Over-voltage during operation:** if the AC mains voltage surges by roughly 10% or more during operation, the preamplifier will enter protection mode and shut down. The **Standby LED** will flash to indicate the protection mode has been engaged.
- **Under-voltage during operation:** if the AC mains voltage sags by 15% or more, the preamplifier will continue to play (since this does not present a particular danger to the amplifier), but note that it may not be able to achieve its usual standard of performance under these compromised conditions. The **Standby LED** will flash to indicate the condition.



**warm up/break-in period**

Your new Classé preamplifier will deliver outstanding performance immediately. However, you should expect to hear it improve somewhat as it reaches its normal operating temperatures and its various components “break-in.” It has been our experience that the greatest changes occur within the first 300 hours, as the preamplifier reaches thermal equilibrium and the capacitors fully form. After this initial break-in period, the performance of your new product should remain quite consistent for years to come.

The only exception to this rule is if the unit is unplugged for an extended period of time, allowing it to cool down. Depending on the degree of cooling involved, you should expect a brief warm-up period before the preamplifier’s sound quality is at its best. Unless your preamplifier was allowed to become quite chilled, subsequent thermal re-stabilization should not take long. Fortunately, you should never have to repeat the initial 300 hour break-in period.

**please read this manual...**

Please take a few minutes to review this manual, and to familiarize yourself with your new preamplifier. We understand that you are anxious to plug everything in and get started. However, reading this manual and following the advice it gives will ensure that you get all the benefits you deserve from having purchased such a fine piece of equipment .

# Special Design Features

## flexible graphic user interface

The LCD touchscreen on the front panel of your new component supports an extremely flexible and versatile graphic user interface (GUI) while maintaining a clean, uncluttered appearance. The CP-700 provides a range of controls that might otherwise require dozens of buttons and knobs on the front panel. Despite this power and flexibility, it remains simple to operate in day-to-day use.

In fact, in some ways it is even simpler to operate than a more conventional design might be. For example, if you are not using one or more of the inputs on your CP-700, you can delete the unnecessary buttons from the operational menu. Doing so prevents anyone from trying to select a non-existent source component, with the resulting confusion stemming from the lack of any sound. *(Of course, you can easily restore the button if you subsequently add another source component and need that input.)*

## customizable volume control

The volume control on your new Classé preamplifier is controlled by sophisticated software that allows you to fine-tune its response to suit your preferences.

Ideally, a volume control would allow you to reach the volume you desire quickly, and would also provide extremely fine control once you are close to the “perfect” volume. Of course, these characteristics are in conflict with each other: one requires the volume to change by quite a lot for a given amount of turning of the knob, while the other requires small, incremental changes for the same turn of the knob.

The volume control system on your CP-700 solves this problem by responding differently based on the specific circumstances (e.g. how quickly you are turning the knob and where in the volume range you are). After extensive testing, we feel we have created factory default settings that most people will find intuitive and a real pleasure to use. However, if you feel you would like to fine-tune its performance further in order to suit your particular preference, you may easily do so.

## highly refined circuit design

All Classé analog amplification stages are based on circuits that have been extensively optimized over many years of continuous development.

By starting with excellent circuit designs and working with them over the years, we are able to discover the many small refinements that add up to superlative performance, in a variety of applications. Altering a voltage here, or using a slightly different part there, may make all the difference between solid and absolutely outstanding performance.

This level of refinement only comes with a great deal of experience, and is not available to those who flit from one trendy notion to the next. It accounts in no small measure for both the consistency of sonic performance among Classé products (as they are all based on similar analog gain stages), and for the consistently excellent reviews these products receive from owners and reviewers alike.

## **extensive listening tests**

Excellent measured performance is to be expected in world-class products, and Classé products deliver that performance. However, experience has shown that technical excellence alone is insufficient to guarantee subjectively musical results.

For this reason, all Classé products are laboriously fine-tuned during the development process by carefully controlled listening tests. Our ears are still some of the finest laboratory test instruments available, and nicely complement more traditional engineering test equipment. In the course of optimizing the circuitry for a product, hundreds of decisions are made based on the subjective impression given by substituting one high quality part for another.

As an example, we may listen to half a dozen 0.1% tolerance film resistor components of the same value, from several different companies. Standard tests may show them all to provide identical results in terms of noise, distortion, and so forth. Yet, almost invariably, one selection yields some small improvement in the subjective reaction to the performance of the product under development. Less often, even a single such change can result in a surprisingly large improvement.

Multiply those various improvements by the dozens or even hundreds of such decisions that must be made before the product can be finalized for production, and you have a remarkable improvement, indeed – all based on careful listening tests, which we view as a necessary complement to the solid engineering you might rightly expect from Classé.

## **extraordinary longevity**

Another benefit of having worked with highly refined circuit designs so extensively over many years is that we have vast experience in what works well over the long term.

By using only the highest quality parts to begin with, and then using them in an informed way as a result of both accelerated aging experiments and actual long-term experience, we are able to design and manufacture products which we are confident will stand the test of time.

We are confident that your new Classé preamplifier will give you many years of trouble-free reliability and musical enjoyment, just as previous Classé products have given their owners.

## **robust, isolated power supplies**

The CP-700 employs an outboard power supply to provide the ultimate in performance. This unit includes a massive 135 VA toroidal transformer with five secondary windings to provide maximum isolation for both the positive and negative voltages required by each channel, as well as the voltage used by the control circuitry within the preamplifier itself.

This design approach ensures that the preamplifier itself sees only the pure, highly-regulated DC power it needs for handling the music signals, while the high-voltage AC mains is kept safely away from your music. In short, it creates an ideal environment in which the refined circuitry of the CP-700 can operate to its full potential in service of your musical enjoyment.

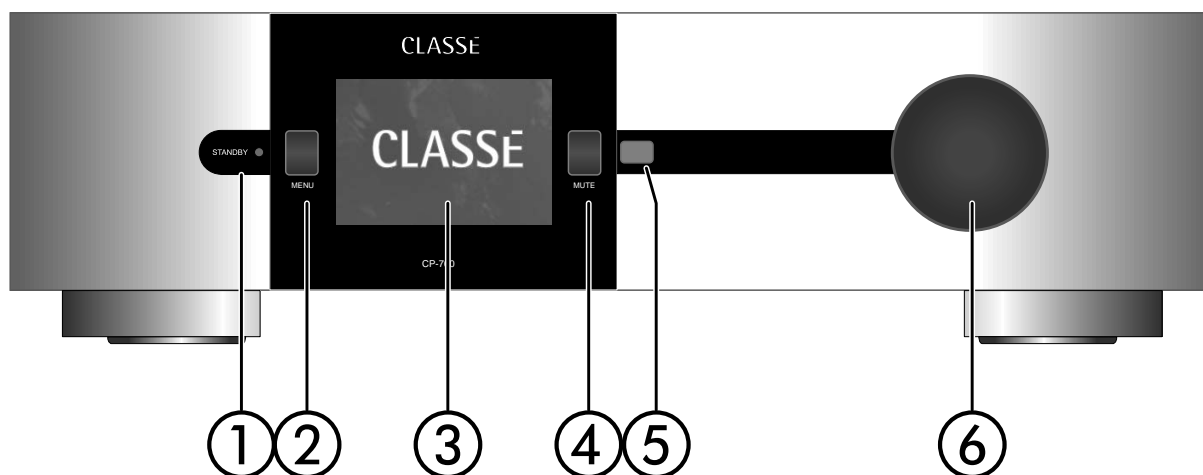

## Front Panel

### 1 Standby button & LED indicator

The front panel **Standby** button will toggle the preamplifier between *operate*, its fully operational state, and a *standby* mode that leaves the preamplifier off, yet ready to respond to system commands via any of the supported control options (e.g. IR input, DC trigger, CAN-Bus, or RS-232).

The current state of the preamplifier is indicated by the **LED** indicator in the center of the standby button. When the unit is powered and switched on, the state of this LED indicates the following:

- on = *standby*
- flashing (*on power-up*) = *initialization*
- off = *operate*
- on (*dim*) = *display timeout*
- flashing (*after power-up*) = *AC mains voltage out of range*

If you are planning not to use the preamplifier for an extended period of time, e.g. vacation or other travel, we suggest you disconnect it from the AC mains. Please be certain that the preamplifier is turned off prior to disconnecting it from the AC mains.

Also, it is a good practice to physically disconnect any and all valuable electronics from the AC mains during electrical storms, as a lightning strike anywhere near your home can put a tremendous surge on the AC mains that can damage any piece of electronic equipment, no matter how well designed and protected. The best protection in the case of severe electrical storms is simply to remove the electronics from any connection with the power grid.

## 2 **Menu button**

Pressing the front panel **Menu** button will call up the *main menu system*, replacing the normal operational menu and status display in the LCD touchscreen.

## 3 **LCD touchscreen**

Much of your interaction with the CP-700 will be via the **LCD touchscreen** (and the CP-700's supplied remote control). It will usually display the various **input selection** buttons you would use in day-to-day operation, along with access to the tape button.

By pressing the **Menu** button, you can also call up the *menu system* of the CP-700, which gives you control over many of the operational details of the preamplifier, including *system setup* options, various *display* options (including the *language* in which the menu system itself displays), and several custom-installation capabilities that allow superior integration of the CP-700 into complex systems.

For more information, see the section *The Menu System* later in this manual.

## 4 **Mute button**

The front panel **Mute** button reduces the volume of the preamplifier to zero at the touch of a button. Pressing the button a second time restores the volume to its previous setting. The behavior of the mute can also be customized. Setup information on this feature is available in the *Volume Setup* section.

However, if you increase the volume manually (using either the **volume knob** or the **remote control**) while the **Mute** button is engaged, the mute control will disengage and the volume will be set to zero. This approach is a safety measure, to avoid situations in which the volume might be adjusted up while muted, only to then have the system un-muted to an unexpectedly high volume.

## 5 **IR window**

The **infrared (IR) receiver** and **transmitter** are located behind this window. Ordinarily, your Classé CP-700 must be able to “see” the remote control from this window in order to respond to remote control commands.

If your preamplifier will be located behind closed doors, or for any other reason will not be able to “see” the remote control during normal operation, you may use the rear panel **IR input** and **output** mini-jacks and an *IR repeater system* to solve the problem. For more information about using an infrared repeater system to route signals to and from the CP-700, refer to the section *Rear Panel* later in this manual, or contact your local Classé dealer.

In addition to receiving IR commands, the CP-700 can also transmit IR commands so they may be learned by third-party learning remote controls. The CP-700 includes a comprehensive list of discrete IR commands to facilitate the creation of reliable macros. Specifically, there are discrete codes for all commands that normally operate as toggle functions (e.g. separate *operate* and *standby* commands in addition to the normal command that toggles between the two states).

## 6 Volume Knob

The large **knob** on the right side of the front panel of the CP-700 is used to control the volume of the system.

The volume is raised or lowered in precise 0.5dB increments throughout the range of the control most likely to be used while listening to music.

At extremely low volumes, the step size is increased somewhat to make it easier to move quickly between extremely low and normal listening levels.

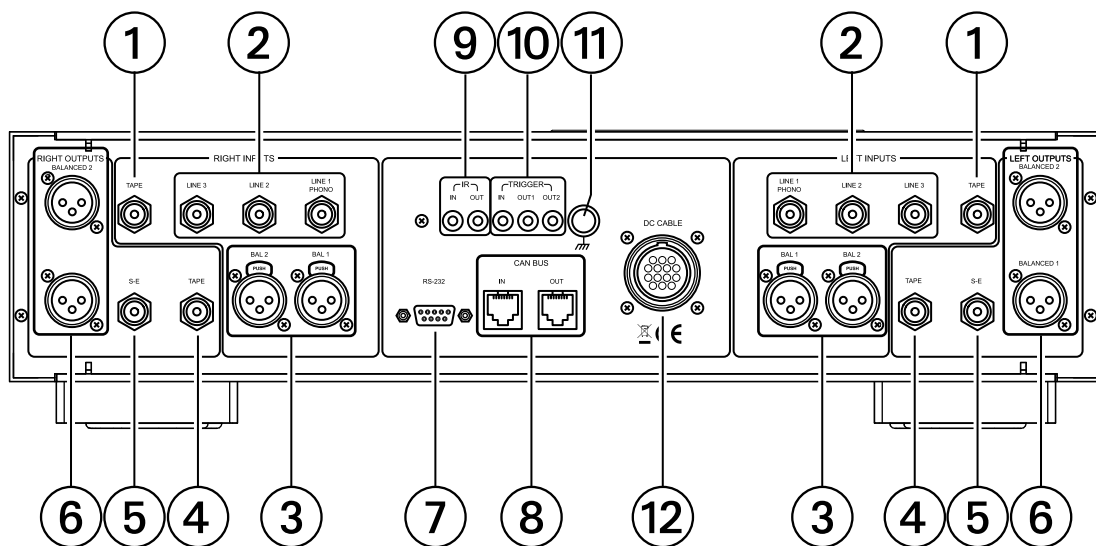

## Rear Panel

### 1 Tape Input

Connect the analog outputs of any recording device (analog tape recorder, digital tape recorder, CD recorder, etc.) you may have to these single-ended **RCA** connectors. You may select to hear the output of your recording device by touching the **tape** button on the main operational screen of the CP-700.

### 2 Single-ended (RCA) inputs

These RCA jacks accept right-channel and left-channel (single-ended) inputs from line-level source equipment such as tuners, CD players, and tape decks. Any of these inputs may be selected by touching the corresponding button on the main operational screen of the front panel touchscreen.

To achieve the best possible results, we suggest that you use only high-quality, shielded interconnect cables. Please consult with your local Classé dealer for advice on the best cables for use in your system.

*optional phono preamp*

If you have a turntable you would like to use with the system, an optional phono preamplifier module is available from your Classé dealer. Once installed in your preamplifier, the **Line 1** input connectors become your **phono** inputs, and the **phono gain** control in the menu system becomes active, allowing you to select either *low gain* for all moving-magnet (MM) and high-output moving-coil (MC) cartridges, or *high gain* for standard output MC cartridges. (See the section *The Menu System* for more information.)

### 3 Balanced (XLR) inputs

These **XLR** jacks accept right-channel and left-channel balanced signals from source equipment with balanced outputs. Either of these inputs may be selected by touching the corresponding button on the main operational screen of the LCD touchscreen.

The pin assignments of the XLR-type female input connectors are:



- Pin 1: Signal ground
- Pin 2: Signal + (non-inverting)
- Pin 3: Signal – (inverting)
- Connector ground lug: chassis ground

Refer to the operating manuals of your balanced-output line-level sources to verify that the pin assignments of their output connectors correspond to the CP-700. If not, wire the cables so that the appropriate output pin connects to the equivalent input pin.

To achieve the best possible results, we suggest that you use only high-quality interconnect cables. Please consult with your local Classé dealer for advice on the best cables for use in your system.

#### 4 Tape output

Connect these **RCA** jacks to the right-channel and left-channel recording inputs of your recorder.

These single-ended RCA outputs are unaffected by the volume control on the front panel, or by whether you choose to monitor the source or the recorder (*by having the “tape” button on the front panel’s touchscreen deselected or selected, respectively*). The record outputs will be disconnected when the preamplifier is placed into *standby*, however.

#### 5 Single-ended (RCA) main outputs

Single-ended cables using RCA connectors are the most common form of analog connection used in consumer electronics. When implemented carefully and used with high quality interconnect cables, this standard can provide excellent performance.

Classé has gone to extraordinary effort to ensure that the single-ended (RCA) outputs of your preamplifier are as good as possible. However, this connection standard cannot offer the immunity from interference that balanced interconnection does—hence our recommendation to use the balanced outputs whenever possible.

If you are not using balanced analog interconnection, then connect these single-ended outputs to your preamplifier using high-quality shielded RCA-terminated cables. Your Classé dealer can advise you on the selection of cables suitable for your system.

#### 6 Balanced (XLR) main outputs

The CP-700 supports two pairs of high quality XLR outputs to provide balanced stereo analog signal to your power amplifier(s). In most cases, you will connect one pair only to corresponding balanced inputs on your power amplifier, using shielded high-quality balanced interconnects. If you choose to biampify your speakers, you may need to use both outputs. Your Classé dealer can provide assistance in selecting appropriate balanced cables for your system, as well as advice on the potential benefits of biampification in your particular situation.



Balanced audio interconnections were originally developed in the professional audio world for preserving the delicate nuances of extremely small microphone-level signals. For many years now, they have also been used by performance-oriented consumer companies like Classé to preserve every nuance of the finest audio performances in your collection.

Technically, balanced audio interconnections provide two distinct benefits: they double the signal's strength as it travels from one component to the next, increasing the potential signal-to-noise ratio by 6 dB; they also do an excellent job of rejecting noise and interference that might otherwise be picked up between the components, due to either EMI (electromagnetic interference) or RFI (radio frequency interference). In the world of wireless telecommunications, there is more potential interference around than ever before—it makes sense to keep it out of music and movie soundtracks.

For this reason, we strongly recommend using balanced analog interconnects between your Classé components wherever possible, especially if you plan to use long interconnect cables between your preamplifier and the power amplifier(s) in order to minimize the length of the speaker wires.

The pin assignments of these XLR output connectors are:

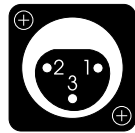

- Pin 1: Signal ground
- Pin 2: Signal + (non-inverting)
- Pin 3: Signal – (inverting)
- Connector ground lug: chassis ground

These pin assignments are consistent with the standard adopted by the Audio Engineering Society (AES14-1992).

If you are using your Classé preamplifier with a Classé power amplifier, you're all set – just take standard balanced interconnect cables and plug them in.

If you are using another brand of power amplifier, please refer to the operating manual of your amplifier to verify that the pin assignments of its input connectors correspond to those of the CP-700. If not, have your dealer wire the cables so that the appropriate output pin connects to the equivalent input pin.

## 7 RS-232 Control Port

This **DB-9** connector has two purposes:

- downloading new operating software into your preamplifier (should new features ever be added, for example)
- external control of your preamplifier by control systems such as i-Command™, AMX® and Crestron™

For more information, please contact your dealer and ask about home automation systems.

## 8 Classé CAN-Bus Control Ports

These **RJ-45** connectors are reserved for future control and communication applications using Classé Audio's implementation of the Controller Area Network (CAN) Bus specification.

## 9 IR Input and Output

Your Classé preamplifier includes two 1/8th-inch **mini mono-jacks** in order to support the infrared (IR) remote controls that are ubiquitous today. Infrared commands exist (for example) for *toggling* the preamplifier between *operate* and *standby*, in addition to discrete command codes for either *operate* or *standby*. These codes may be used in "macros" for sophisticated remote control systems, facilitating the control of the preamplifier in the larger context of a complete system.

The list of commands available is quite extensive, enabling even complex *macros* (chains of commands strung together) to operate flawlessly. If this capability is of interest to you, we strongly recommend discussing it with your authorized Classé dealer.

Note that *IR Input* and *Output* is a bit of a misnomer: the input and output of these plugs is *electrical* in nature, not infrared. They are used with standard IR receivers, distribution amplifiers, and emitters (available from your dealer) to translate the remote's IR signal to an electrical signal and *vice versa*. The big advantages here include being able to easily route the signals anywhere they might need to go and the reliability of a solid electrical connection.

Since an IR distribution system such as your dealer may design for you usually must control many products, your preamplifier includes both an **IR input** (for the control of this product) and an **IR output** (so as to pass along the same signal to the next product). This allows you to "daisy chain" your control wires from one product to the next.

The preamplifier is designed to respond to IR commands of 5 Volts DC, with the tip of the mini-plug defined to be positive relative to the shank of the plug.

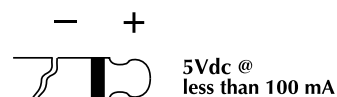

## 10 DC Trigger Input and Output

Many audio/video components can supply a DC control voltage to associated equipment in order to induce desired behavior. Your Classé preamplifier can take advantage of these capabilities in order to be switched between *operate* and *standby* automatically, usually in concert with the A/V preamp itself.

The 1/8th-inch mini mono-jack **Trigger In** provides for remote-controlled turn-on (that is, toggling between *operate* and *standby*) of the preamplifier.

Two 1/8th-inch mini mono-jacks provide individually controllable DC trigger outputs which can be used for any of a number of purposes, as described in *The Menu System*. For example, your dealer can program **Trigger Out1** to toggle your Classé power amplifier between operate and standby with your CP-700.

The remote trigger input will respond to the presence of 5–12VDC, with tip polarity as shown below:

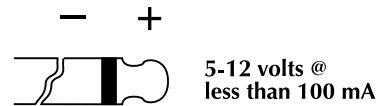

Similarly, the trigger outputs will create a 12VDC signal that can source up to 100mA of current.

## 11 Ground terminal

The ground terminal on your preamplifier is most often used for the ground wire of a turntable, assuming you have the optional phono module installed (see your authorized Classé dealer for more information on this option if you are interested). Connecting the ground wire from your turntable's tonearm to this screw terminal usually minimizes any hum or buzzing to which the turntable might otherwise be susceptible. Your authorized Classé dealer can assist you in handling this problem if it should arise.

## 12 DC Power Input

The **DC Power Input** for the CP-700 is located near the middle of the rear panel. Connect the provided multi-pin “umbilical cord” between the outboard power supply and this connector to provide the preamplifier with the clean, pure DC power it needs to do its job.

There is also an AC mains switch on the back of the outboard power supply. Switching the power supply on (assuming the preamplifier is connected with the umbilical cord) puts the preamplifier in *standby* mode. The preamplifier should also be in *standby* before power is switched off.



**Danger!**

---

**Potentially dangerous voltages and current capabilities exist within your power supply, even when disconnected from AC mains. Do not attempt to open any portion of the unit's cabinet. There are no user-serviceable parts inside. All service of this product must be referred to a qualified authorized Classé dealer or distributor.**

---

# The Remote Control

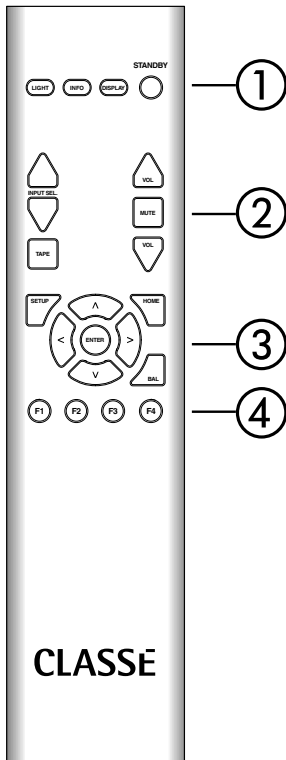

Your new preamplifier comes with a versatile **remote control** which can control both the CP-700 itself and several aspects of the rest of a Classé-based system. The buttons are arranged in logical groups according to their functions.

## 1 Basic Functions

This section along the top of the remote control groups four functions that control your basic interactions with the CP-700.

- **Light** switches the backlighting of the remote control on, for better visibility under low-light conditions. After a few moments of inactivity, the backlight switches off automatically.
- **Info** takes you directly to the status screen in the LCD menu system, displaying several items of information about the CP-700 and its current operational status.
- **Disp** (for *Display*) cycles through the three brightness settings of the screen display.
- **Standby** toggles the CP-700 between standby and operate.

## 2 Input Selection & Volume

The **Up** and **Down** arrow keys on the left side of the remote control will cycle through the active inputs on your CP-700.

If you have inputs you are not using, we suggest deactivating them in order to provide faster, easier access to the inputs you are actually using. (See the section *The Menu System* for information on how to do this.)

The **Up** and **Down** arrow keys on the right side of the remote control will raise and lower volume; the square key between them will activate the **Mute** function of the CP-700 (as defined in the menu system; see *The Menu System* for more on your mute options).

## 3 Navigation Keys

The central section of the remote control contains the navigation keys. This array of buttons is similar to what you may have seen on remote controls for DVD players, and is used for navigation of the menu system of the CP-700.

- **Home** returns you to the normal input selection controls normally shown on the LCD screen on the front panel of the CP-700. This provides a quick way to get back to normal operation, regardless of how deep you might be in the menu system.
- **Menu** serves two functions: it calls up the menu system when you need it in order to adjust something to your preference; once within the menu system, pressing **Menu** returns you to the previous level of the menu system. If you press **Menu** when at the top level of the menu system, it will take you back out of the menu system to the normal display.

- The **Bal** (balance) key takes you directly to the **balance** screen in the menu system; once there, you can use the navigation keys on the remote to select either the **left** or **right** buttons on the LCD touchscreen, depending on which way you wish to move the balance. Adjust the relative left-right balance of the system by using the **Enter** key on the remote to “press” the appropriate button on the display.
- **Up/Down/Left/Right** keys allow you to move within a particular menu screen, changing the highlighted item up/down/left/right as you like, from the comfort of your listening position.
- The **Enter** key allows you to select the highlighted item, having the same effect as if you had pressed the button on the LCD touchscreen.
- The **Tape** key is not a navigation key, per se, but allows you to easily toggle between listening to the selected source and listening to the output of your recording device. If you have a recording device (such as a three-head tape deck) which can play back a recording while it is being made, you will be able to compare the original signal to the recording while you are making it.

#### 4 Fkey Controls

The CP-700 remote control can also control user-defined functions as well. The **F1/F2/F3/F4** keys are available for controlling aspects of the CP-700 not covered by the other buttons on the remote control.

You are able to choose what the CP-700 should do in response to receiving the infrared signal that a particular **Fkey** has been pressed. The list of possible functions is quite extensive, and is found in the menu system (see the next section in this manual, entitled *The Menu System*).

---

**Note:**

**The Fkeys on all Classé remote controls issue the same infrared commands. This saves you from having to be sure you have picked up the proper remote, since all your Classé remotes will perform the same function for each Fkey.**

---

# The Menu System

Your CP-700 includes a versatile **LCD touchscreen** which supports both an attractive information display and a flexible menu system. While its use is quite intuitive, it is also quite extensive. This section of the owner's manual outlines the many capabilities found in the menu system.

## operational menu

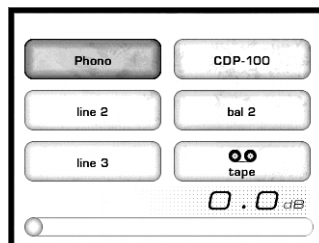

The **operational menu** provides easy access to the most basic functions of the preamplifier: **input selection** and **tape monitor**. It also provides both a numeric and a graphic depiction of the current **volume** setting.

## input selection

Pressing any of the input buttons on the touchscreen will switch to the appropriate input. You may have as many as three *line* inputs (meaning single-ended connections using RCA connectors) and two *bal* inputs (balanced connections using XLR connectors). If you do not have this many sources in your system, you can elect to deactivate the unused inputs. Doing so removes their associated buttons from the touchscreen, reducing confusion for occasional users of the system.

## tape loop

In addition, the CP-700 has a dedicated **tape loop** for use with sources that can both record and play back, bringing the total number of sources you can connect to the CP-700 to six (four single-ended and two balanced).

When you touch the **tape** button to highlight it, you will notice that the previously selected input remains highlighted. Whenever any input is selected for listening, it is also selected for possible recording; a copy of its signal is sent to the recording device connected to the tape output. You may record it or not as you please.

When you select the **tape** button, you are asking the CP-700 to continue with this recording feed (whether or not it is being used), while switching to monitor the output of the tape deck (or CD recorder, or whatever else you might have connected to the record loop). In this way, you can monitor the result of your recording while you are making it, in real time. (*This assumes that your recording device supports this capability, as do three-head tape decks.*)

## main menu system

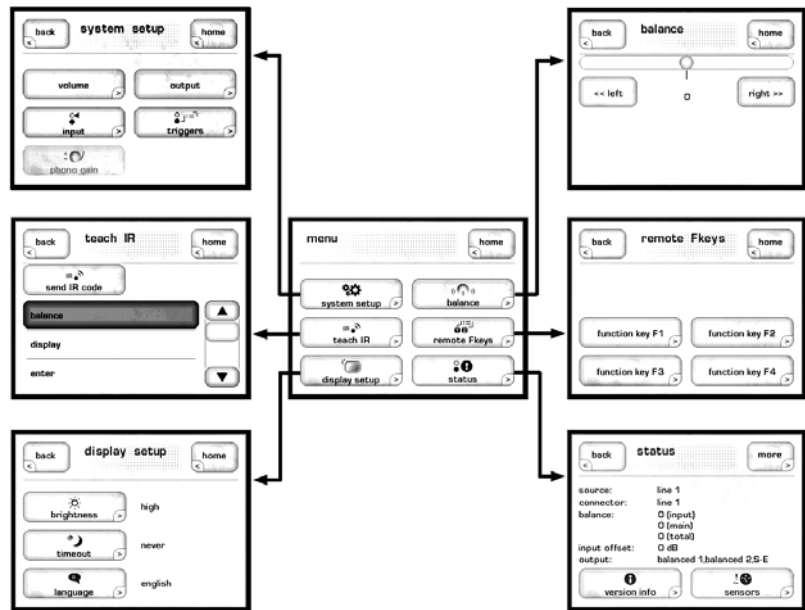

Pressing the front panel **Menu** button to the left of the **LCD touchscreen** brings up a comprehensive *main menu system*, the top two levels of which are shown above. This menu provides access to many installation-specific features that let you customize how the CP-700 works within the context of your particular system.

## system setup

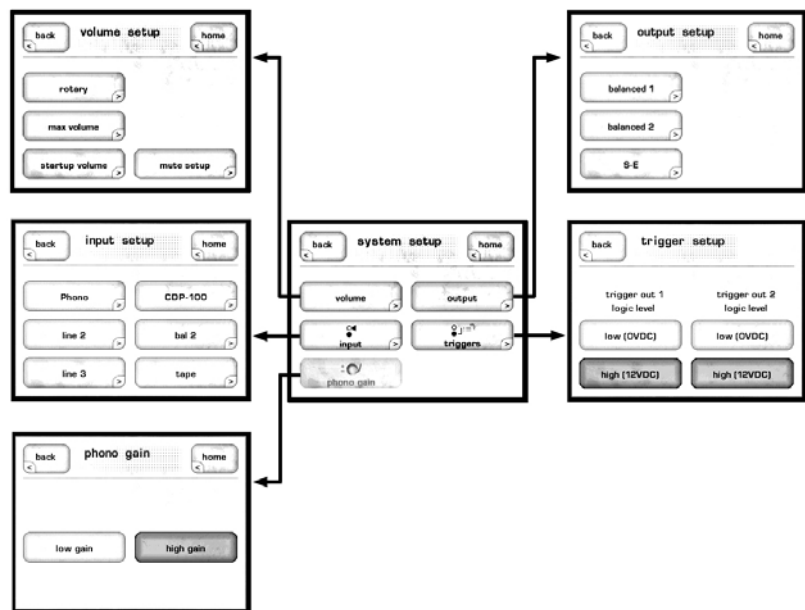

The first button on the control menu takes you to a series of submenus that collectively provide a great deal of control over your system setup. Here, you can:

- customize the behavior of your volume control
- tailor your inputs to your particular source components
- adjust the gain of the optional phono module
- activate and name your three sets of main outputs
- program the behavior of the CP-700's DC triggers

*volume* Pressing the **volume** button takes you to the volume setup menu, which in turn has four submenus, all pertaining to how the volume of the system is managed.

- **rotary**
- **max volume**
- **startup volume**
- **mute setup**

Each of these topics will be addressed in turn, below.

*rotary* The rotary knob on the front panel does not directly control the volume. Instead, it controls circuitry that does so with greater fidelity and precision than traditional volume potentiometers could ever achieve.

Since the volume control circuitry is under software control, it is possible to customize its behavior under various conditions. To better understand why this is so valuable, consider two scenarios:

*Person A places a high value on precision in achieving exactly the volume setting that makes the music most realistic; being able to easily change volume setting by a fraction of a decibel is critical to his enjoyment of the system.*

*Person B just wants to jump easily from low volumes to a reasonable listening level, and is less concerned with the finer points of precision than with getting what he wants with a quick twist of the knob.*

You can see the problem in these scenarios: Person A wants extremely fine gradations on the volume control, which will require many rotations to go from extremely low setting to normal listening levels; Person B wants to get from one to the other with a “quick twist” of the knob, requiring coarse gradations in order to cover so much range in so little space. What happens when Persons A and B live in the same house? Or if Person C wants to have both, depending on their mood at the moment? (*In fact, most of us are probably like Person C.*)

Classé solves this dilemma by altering the response of the volume control, based on several factors.

Since it is rare to listen at extremely low (barely audible) volumes, the *low range* adjustment of the volume control allows for faster response to knob input when the volume setting values are low. When activated, you will get from extremely low to middle volume control settings a bit faster than you would otherwise. This effect can be subtle, and may not even be desirable when the speakers used have extremely high sensitivity (since this results in using the lowest part of the range more than you would otherwise).



The most significant factor in the perceived responsiveness of the volume control is the *speed* at which the knob is being turned. We all naturally tend to move volume knobs more quickly when we need to make a bigger change, and we tend to slow down as we approach our desired volume. Thus, if the CP-700 sees the knob moving relatively quickly, it uses coarse steps to effectively accelerate the action of the circuitry. As the knob begins to turn more slowly, the CP-700 will actually increase the resolution of the steps, which slows down the action of the volume control and yields greater precision in choosing an appropriate setting.

Of course, it is possible to bump into the knob by accident, which might result in its spinning very quickly indeed. Rather than increasing the volume uncontrollably under these conditions, the CP-700 actually slows everything down again as a safety measure against accidentally blowing your speakers. In fact, if you like you may establish a speed limit beyond which the knob will simply be ignored.

The *factory default* settings for these behaviors are generally found to be intuitive and a pleasure to use. However, if you prefer to alter these behaviors, you may do so in the rotary menu, shown below.

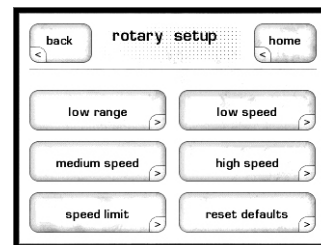

All of the **rotary setup** settings are interactive. You can set the value, and then adjust the volume to see whether the effect is what you desired.

- **low range:** determines the degree to which the responsiveness of the volume control is boosted at low volume control settings, in order to get through them more quickly. A setting of 0 disengages the effect, while a setting of 100 maximizes it.

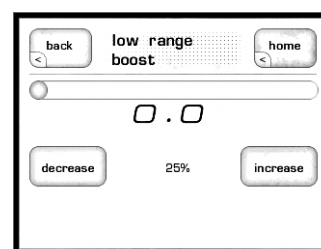

- **low speed:** determines the responsiveness of the control when the knob is being turned slowly. A setting of 0 will cause the volume to change as slowly as possible at low knob speeds; a setting of 100 will cause the volume to change as quickly as allowed at low knob speeds. (*The menu is the same as the one above except for the indication that it is for the “low speed” adjustment.*)

- **medium speed:** determines the responsiveness of the control when the knob is being turned at a moderate speed. A setting of 0 will cause the volume to change as slowly as possible at medium speeds; a setting of 100 will cause the volume to change as quickly as allowed at medium knob speeds. (*The menu is the same as the one above except for the indication that it is for the “medium speed” adjustment.*)
- **high speed:** determines the responsiveness of the control when the knob is being turned rapidly. A setting of 0 will cause the volume to change as slowly as possible at high knob speeds; a setting of 100 will cause the volume to change as quickly as allowed at high knob speeds. (*The menu is the same as the one above except for the indication that it is for the “high speed” adjustment.*)
- **speed limit:** establishes a maximum rotary speed, beyond which there will be no change in volume whatsoever; the knob’s input will be ignored completely until it is first stopped, and then rotated at a slower speed.
- **reset defaults:** if after experimenting with various settings you decide you prefer it the way it operated as it came from the factory, pressing this button will restore the factory default settings. So feel free to experiment – you can always return to the original settings.

*max volume*

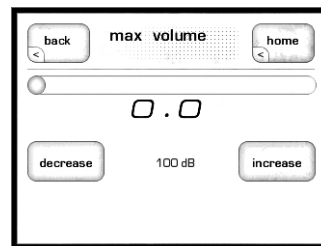

The **max volume** screen allows you to establish a maximum volume setting for your system. This scale runs from 0 to 100, with 100 indicating that you do not want any artificial limit placed on the maximum gain your preamplifier can provide.

This setting is interactive. You can set the value to something less than 100, and then adjust the volume to see whether it is appropriate.

*startup volume*

The **startup volume** screen allows you to define how the CP-700 handles its initial volume upon starting up. Your choices are:

- **last volume:** this setting causes the CP-700 to behave as do basic preamplifiers that use simple potentiometers for their volume control. The turn-on volume is whatever it happened to be when last used.
- **specific:** alternatively, you can elect to have a specific startup volume of your choosing. Select the specific button, and then set your preference by clicking the **set volume** button beside it. The latter button takes you to a screen in which you can both see and hear the setting you are choosing (assuming you are playing music at the time. Setting a relatively low startup volume ensures that you do not accidentally disturb anyone when first turning on the system.

## *mute setup*

Pressing the **mute setup** button allows you to select one of three different muting functions:

- **Classic** muting literally mutes the output when you engage the **mute** button; no sound will be heard.
- **Specific** muting allows you to select a specific volume setting that you want used when you engage **mute**, regardless of what setting you might have been using the moment before.
- **Dampening** works as most **mute** buttons work, attenuating the current volume by the amount you specify.

## *input*

Each input on your preamplifier can be customized in several ways to enhance either the performance or the ease of use of the system. A quick look at the input menu and submenus gives you an overview of what is possible:

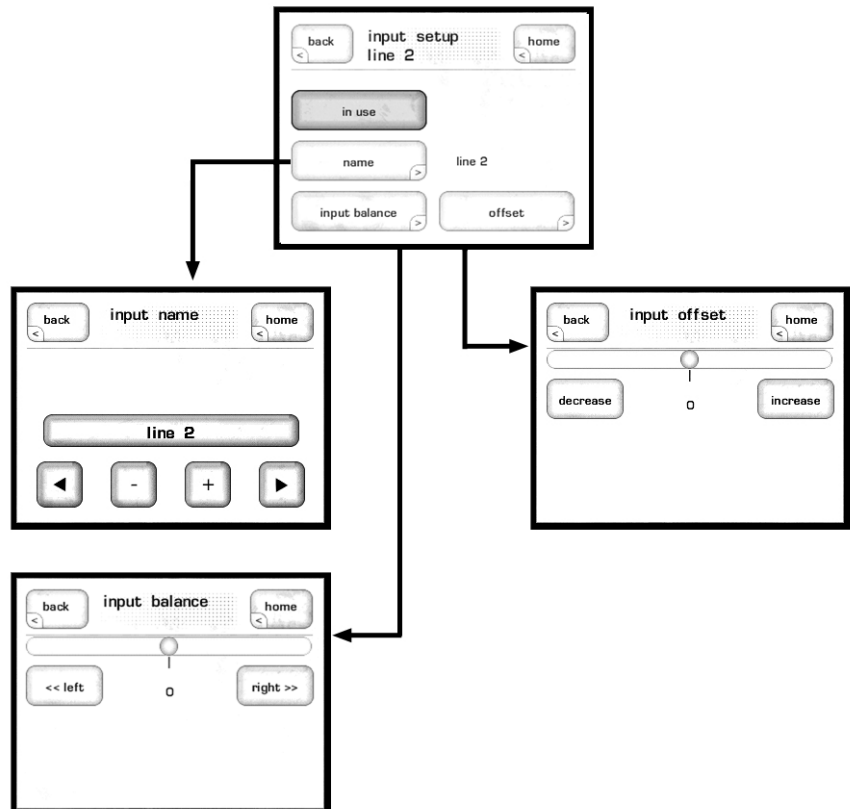

- **in use** determines whether the selected input is displayed on the main input selection screen, and whether it is included in the rotation of inputs cycled through from the remote control's input selection buttons.
- **name** provides a way to customize the names of the inputs as displayed on the main input selection screen. For example, you might want to name your **Bal 1** input "CDP-100" for the Classé CD player you might have connected to that input. To do so, use the four buttons along the bottom of the **input name** menu to change the default name of any given input to something more specific to your system.

- The ◀ button acts like the backspace key on a computer keyboard, moving the cursor to the left and eliminating any characters along the way.
- The ▶ button moves the cursor to the right, adding characters along the way. (Change each character to what you want as you go along, using the + and – buttons.)
- The + and – buttons change the current character through the available characters. They include all upper and lower case letters of the alphabet, the numbers 0-9, and a variety of punctuation. When done, your main display might look like this (note the change in what would otherwise be the **bal 1** input).

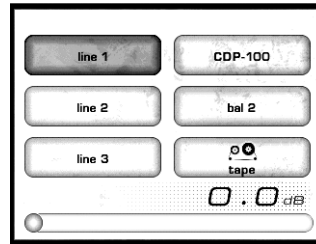

### Warning!

When an input is renamed 'SSP', it becomes a unity gain input. When such an input is selected, the volume control of the CP-700 is disabled, all outputs are driven at line level and the volume indication is removed from the main menu.

This is useful in situations where the CP-700 is being used to pass through a signal coming from a component with its own volume control (e.g. Classé SSP-300 surround sound processor), or when one of its outputs is sent to a component with its own volume control (SSP-300). Care should be taken to adjust the volume control of the other component before selecting the SSP input, as the resulting volume level may be uncomfortably loud.

- **input balance** adjusts an input-specific balance adjustment to compensate for the possibility that a particular source might be slightly imbalanced. This is especially common with turntables, since even the finest handmade cartridges are subject to small channel imbalance problems.
- **input offset** provides a way to compensate for differences in output level between various source components. Doing so can eliminate the sometimes annoying and abrupt changes in volume encountered when switching between different source components.

## phono gain

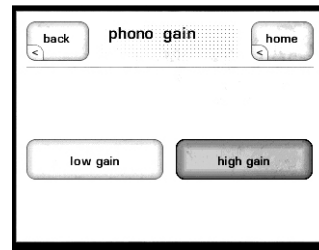

The **phono gain** menu is only active if the optional **phono module** is installed; otherwise it is grayed out. When it is installed, the CP-700 will automatically recognize it, rename the **line 1** input to **phono**, and activate the input on the main menu.

Setting the phono gain is simple enough: choose *low gain* for most moving magnet cartridges, and for high output moving coil cartridges; choose *high gain* for low output moving coil cartridges. Your Classé dealer can assist you in determining what type of cartridge you have, and which setting is most appropriate.

## triggers

Each of the CP-700's **trigger outputs** may be programmed as to its "logic level," which is to say, whether its voltage is *low* (essentially 0V), or *high* (approximately 12V) when the trigger is activated. The ability to change the logic level of a trigger's "on" state can solve installation-specific problems that otherwise require external devices that add to both the cost and complexity of your system.

If this seems an obscure point, that's okay. It is a feature designed to solve problems you may not even have, but your installation professional appreciates being able to easily solve such problems when they occur.

## teach IR

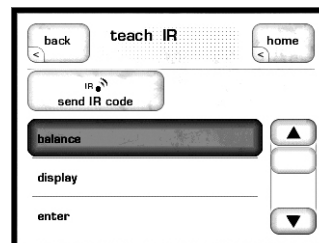

The CP-700 provides discrete infrared (IR) command codes for all its functions, a list that extends far beyond what is required by normal remote controls. However, many of these functions are critical if you plan to create a customized remote control with macros that take command of your entire system. Without these discrete codes, many of the macros you might want to create will simply not work reliably.

The **teach IR** screen provides a scrolling list of all the available IR codes in the CP-700. By scrolling to the command you need to learn into your macro-capable remote, and then pressing the **send IR code** button, the CP-700 will send the appropriate command code out its front panel—where it can be learned by your third-party remote control.

For more information on such control systems, we recommend you speak with your authorized Classé dealer.

## display setup

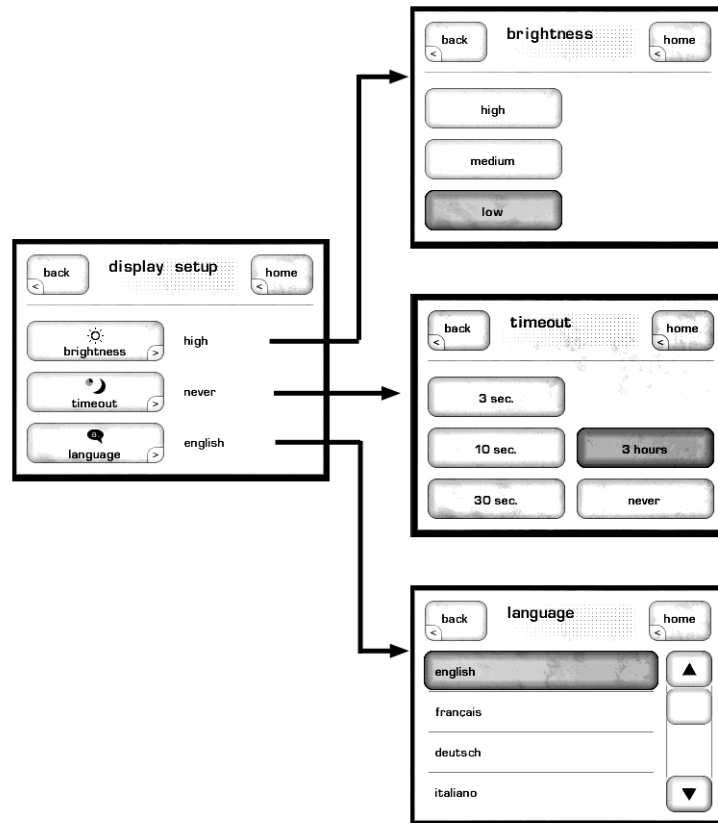

This button brings up the **display setup** menu. It allows you to configure the CP-700's LCD screen *brightness*, the display *timeout*, and the *language* used in the touchscreen and menu system.

### *brightness*

The **brightness** setting of the CP-700 has three possible values: *low*, *medium*, and *high*. Select the appropriate setting based on the level of ambient light typically found in your listening room while using the system. A *high* brightness setting usually works best in brightly-lit rooms; you may find that a lower setting is less visually intrusive under more subdued lighting conditions.

### *timeout*

If you prefer listening to music in a dimly-lit or darkened room, you may find even the *low* brightness setting of the display somewhat distracting. If so, you can vary the **timeout** of the backlighting so as to turn it off entirely after a period of inactivity you select.

In this context, activity refers to any use of the user interface. This includes hard buttons, the LCD touchscreen, and the remote control.

For example, if you reduce the timeout to its minimum setting, the backlighting will illuminate the display as soon as you interact with any of the CP-700 controls, and stay on for only three seconds – just long enough for you to check on something. If you continue to use any of the controls (at least once every three seconds), the display will remain lit. It will then extinguish itself after three seconds of inactivity on your part.

If you prefer the display of the CP-700 to remain on whenever not in *standby*, choose the *never* timeout setting. The lamp in the LCD display was designed for harsh automotive environments and will give you many years of reliable operation. If you plan to leave the unit on continuously, however, we recommend that you keep the timeout delay set to less than one minute. (Note that setting the brightness to a lower setting does not increase the life of the lamp.)

*language*

The **language** menu offers you any of the different languages supported by the CP-700 GUI. Classé has provided our international distributors with a software tool that makes it possible for them to customize the translations to suit their local customs and terminology, in an effort to ensure that the CP-700's operation is as intuitive to use in every country as it is in our home country of Canada.

**main balance**

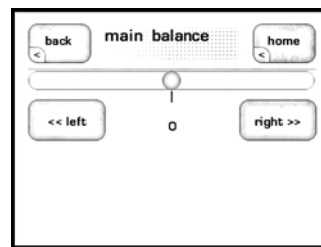

The **main balance** control gives you both a numeric and a graphic indication of the current balance setting for the CP-700.

Some recordings are not balanced particularly well between the left and right channels. If the image presented by a particular recording seems heavily weighted to the left (for example), you can restore a more natural perspective with the balance control. To shift the image to the right, touch the **right>>** button one or more times as needed to correct the perceived imbalance.

**remote Fkeys**

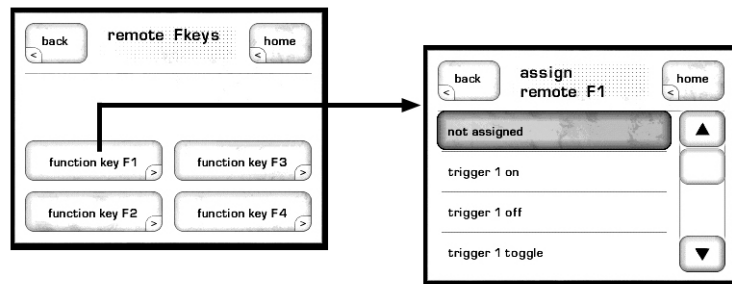

The remote control supplied with the CP-700 has four **function keys (Fkeys)** that allow you to have instant, easy access to specific system functions that might otherwise be buried in a menu somewhere.

For example, if you use the balance control frequently, you may want to consider programming one of the **Fkeys** to take you straight to that screen. Doing so will save you having to access the control menu, followed by pressing the **balance** button (*which might be hard to see from across the room*).

The **remote Fkey** menu has four buttons, one each for the four **Fkeys** on your remote control. Pressing any of these buttons on the LCD touchscreen takes you to a subordinate, scrolling list of possible functions for that particular **Fkey**.

Selecting the one you want is as simple as scrolling through the list (by touching either the up or down arrows on the right), and then touching the specific function in the list that you want that **Fkey** to perform.

*cautionary note on Fkey use*

Note that all Classé remote controls provide these same four **Fkeys**, so that you need not worry about which remote you happen to pick up. Thus **F1** on the preamplifier's remote control sends the same infrared signal as **F1** on the CD player's remote control.

While this is intended to minimize confusion amongst different remotes (since this aspect of them will all perform identically), you should take care when assigning different functions on different components to the same **Fkey**. Doing so would result in two components doing two different things at once, in response to a single press of a button on the remote control. This can sometimes be useful. As an example, **F1** could set the preamplifier to the **CD** input, and also set the CD player to **Play**, both from the press of a single **Fkey**.

**status**

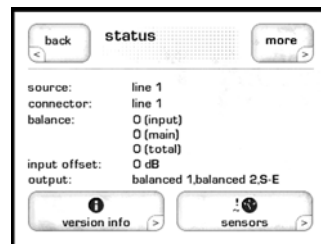

The **status** screen provides several items of information about the current operation status of the CP-700, as well as access to information on the software used in and the internal sensors of the CP-700.

*version info*

The **version info** button on the status screen takes you to the **version information** screen, which displays information on various pieces of software used by your CP-700. If you ever have occasion to call our technical support people to ask a question not covered in this manual, they may want to know precisely what version of software your unit is running. Having this information available will help enable them to give you the best possible service.

*sensors*

The **sensors** button on the status screen takes you to the **sensors** screen, which displays information about several internal sensors within the CP-700. It is unlikely you might ever need the sensor information, unless directed to do so by a customer service representative at Classé in order to help troubleshoot some unexpected problem.



**CAN-Bus** Classé's Controller Area Network, or CAN-Bus, opens the way to a new level of interaction between our Delta range of amplifiers, preamps, processors and source components. When the CP-700 is connected with CAN-Bus, the different elements of a Delta series system are in constant communication, creating a "global" network that delivers system wide status information and shared operational features, all through the touchscreen display.

*features* CAN-Bus will allow a single Delta series touchscreen to:

- Display status information for every connected unit, including amplifiers which do not have a touchscreen display.
- Create a "PlayLink" that allows an SSP or Preamp to automatically switch to the correct input when a Delta series source component starts playback.
- Adjust the global system brightness.
- Configure the entire system to go in and out of standby at the touch of a button and also bring individual components in and out of standby.
- Mute any connected unit.

*hardware setup*

**1 Classé Delta Series Products**

Two or more Classé Delta series products are required, at least one of which must have a touchscreen display.

**2 Category 5 Network Cables**

These are ordinary network cables, commonly used for broadband Internet connections. They should be typical "straight through" cables not the "crossed over" type, and the total required will be one less than the total number of Delta series components in your system.

**3 CAN-Bus Terminator**

A single CAN-Bus Terminator may be required. It is inserted into the CAN-Bus OUT connector of the last component in the CAN-Bus daisy chain. One is included in the box with your CP-700. They are also available free of charge from your nearest Classé Customer Support Centre <http://www.Classeaudio.com/support/service.htm>

**4 SSP-300 & 600 CAN-Bus Interface Box**

Systems that include an SSP-600 or SSP-300 will also require an SSP-300/600 CAN-Bus Interface Box. These are included with the products or available free of charge from your nearest Classé Customer Support Centre <http://www.Classeaudio.com/support/service.htm>

The diagrams below illustrate how to connect the CAN-Bus hardware.

Any combination of models in any order **without** SSP-300 or SSP-600.

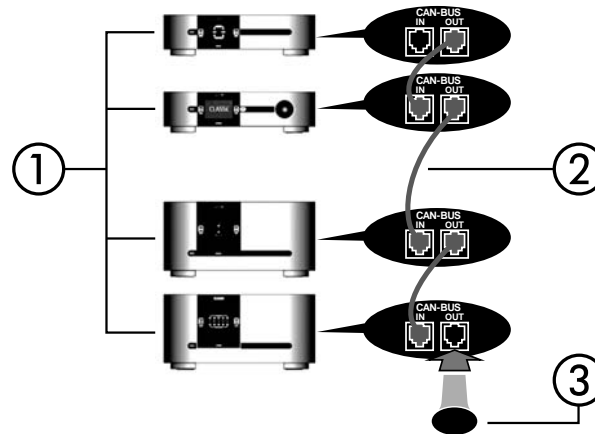

Any combination of models in any order **with** SSP-300 or SSP-600.

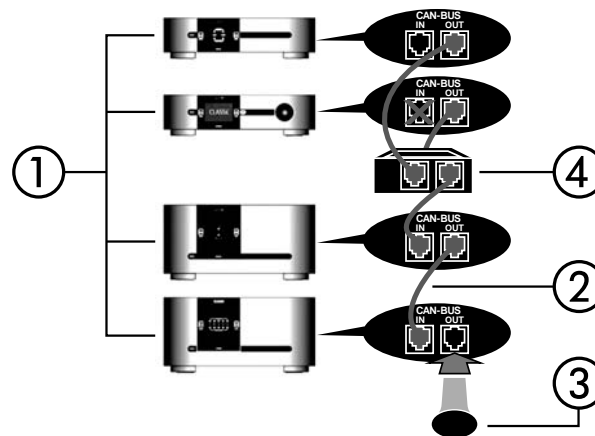

NOTE: Daisy chain may need to be terminated with CAN-Bus Terminator.

*using CAN-Bus*

CAN-Bus is controlled via the touchscreen of any Delta series component. There is no master component, so Delta series systems where two or more units have a touchscreen can be controlled through any of the touchscreens. However, it is probably easiest to start using CAN-Bus through just one.

CAN-Bus is accessed by pressing the **menu** button on the face of the unit or remote, then the **status** button, followed by the **more** button.

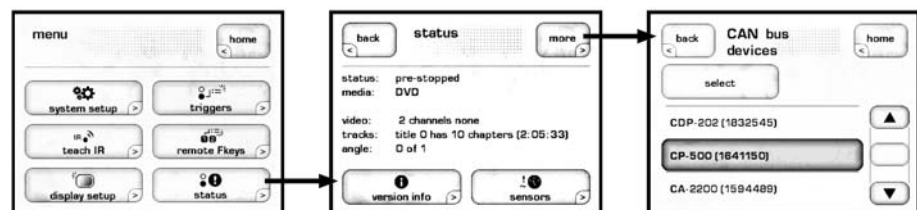

The touchscreen will then display the **CAN-Bus devices** screen, which lists connected Delta series components by model & serial number.

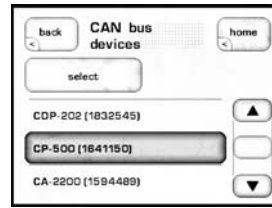

Highlighting a unit on the CAN-Bus devices screen identifies it as the **target unit**. The front panel LEDs of the target unit will start flashing (unless you highlight the unit that you are using to access CAN-Bus).

Once you have chosen the target unit press **select**. The target unit's LEDs will stop flashing and the touch screen will list the CAN-Bus features available to it. Some CAN-Bus features are shared by all models, some are specific to individual models.

**CAN-Bus shared features**

The following CAN-Bus features are shared by all models.

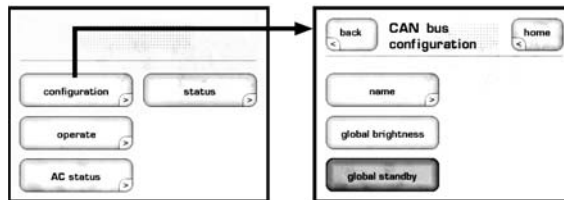

*configuration* Selecting **configuration** will present the **CAN-Bus configuration** screen allowing access to name, global brightness, and global standby features.

*operate* The **operate** settings allow you to bring the target unit in and out of standby, or mute. This key will be disabled for the unit whose touchscreen you are using to access CAN-Bus.

*AC status* The **AC status** screen displays information from the target unit's electrical supply sensors. Two screens are available, with the second accessed by selecting **more**.

*status* The **status** screen is the simplest way to access essential information about the target unit. It displays the target unit's model number, software version, operational status and serial number.

*name* Allows you to set the **name** that this component will be listed under in the CAN-Bus devices screen. The name will appear next to the unit model and serial number, and facilitate the identification of units in large systems.

*global brightness*

By setting all your components to **global brightness** you can adjust the touchscreen and LED brightness for your entire system by changing the brightness of a single touchscreen. All CAN-Bus software updates automatically set the updated unit to Global Brightness. If you want a particular unit to be excluded from Global Brightness, deselect Global Brightness for that unit.

*global standby*

By setting all your components to **global standby** you can bring your entire system in and out of standby by pressing the **standby** button of any unit or remote. All CAN-Bus software updates automatically set the updated unit to global standby. If you want a particular unit to be excluded from global standby, deselect global standby for that unit.

**CAN-Bus model specific features**

The following CAN-Bus features are model specific.

*PlayLink*

This feature is exclusive to Delta series disc players and will only function if the disc player is connected to a CAN-Bus enabled preamp or surround sound processor.

When **PlayLink** is active, pressing **play** on the disc player will also automatically switch the preamp/processor to a specified input. This means that you can listen to a CD or watch a DVD literally at the touch of a button.

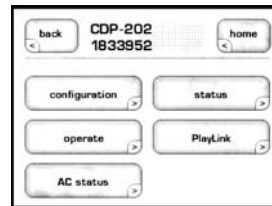

The first step in using PlayLink is to choose the **input** you wish to be selected when play is pressed on the disc player. Press the **PlayLink** icon, then select the correct input from the list.

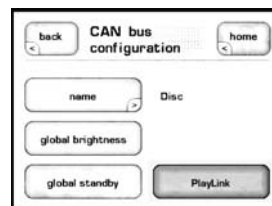

Once you have selected the input press **back**, then select **configuration**. PlayLink is activated and disabled through the PlayLink icon on the CAN-Bus configuration screen.

PlayLink is automatically active after a software update, and the PlayLink icon will only appear on the CAN-Bus configuration screen of a Delta series disc player.

*PlayLink can only select a single input per disc player. It is therefore not designed for users who regularly play both CDs and DVDs through different inputs from a single disc player. When PlayLink is active the disc player will default to the same input every time play is pressed, regardless of whether it is playing CD or DVD.*

*amp info* Available for amplifiers only, this screen displays the data provided by the heatsink and AC Module temperature sensors.

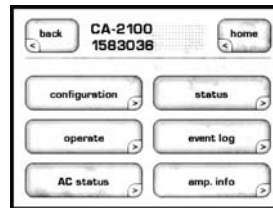

NOTE: This feature is only accessible when the target amplifier is on.

*event log* Reserved for amplifiers, this feature is a protection circuitry **event log** which can only be accessed when the target amplifier is in **standby**. The protection circuit shuts down the amplifier or channel if it overheats or if its output could damage your speakers. The event log details the circumstances surrounding the amp going into protection and should be referred to in situations that require the intervention of your dealer or Classé customer support.

The log can report the following events interpreted as follows:

- **+ve slow blo trip & -ve slow blo trip** — The average current has reached the safe operating limit.
- **+ve fast blo trip & -ve fast blo trip** — The peak current has reached the safe operating limit.
- **over temperature trip** — The unit temperature has reached the safe operating limit.
- **DC protection trip** — The DC output level has reached the safe operating limit.
- **Communication failure** — There has been a loss of communication between the amp's system monitoring sensors.
- **AC line trip** — The power supply has reached the limits of the amp's safe operating range.

These events are rare and generally occur due to issues that are external to the amp. They should be interpreted positively. The amp is doing what it's designed to do.

# Troubleshooting

In general, you should refer any service problems to your Classé dealer. Before contacting your dealer, check to see if the problem is listed here. If it is, try the suggested solutions. If none of these solves the problem, contact your Classé dealer.

## 1. Everything appears to be on, but there is no sound.

- Adjust the volume control to a moderate level (one that should be audible but is not excessive).
- Make sure the source component for which the input has been selected is switched on and is out of its *standby* mode.
- Make sure the proper input has been selected for the source being used.
- Check that the preamplifier is not in *mute* mode. This is indicated by the operational menu icon in the form of a speaker with a bar through it. Press **Mute** to disengage.
- Ensure that the power amplifier is powered up and out of *standby* mode.
- Check if the tape monitor is enabled. If it is engaged and the recorder is off, you will not hear the selected source. Disengage by pressing **Tape**, unless you wish to monitor the recording.
- If the problem occurs only with a particular input, check the interconnect cables between that source and the preamplifier.
- If the problem occurs with all inputs, check the cables between the preamplifier and the power amplifier. If no fault is found there, check the speaker wires for secure connections.



Important!

---

**Check that the power amplifier is off before checking any connections between the preamplifier and power amplifier, or between the power amplifier and the speakers.**

---

## 2. There is no sound and the Standby LED is not lit.

- Ensure the preamplifier is plugged into the AC mains and switched on, and that the AC mains are operating normally. The unit will automatically attempt to protect itself from improper AC mains voltages by not powering up. Make sure your power amplifier is off (if the amplifier is already connected to the preamp) before plugging your preamplifier into the AC mains and powering it up.
- If your preamplifier was plugged in properly, try the following: put it in standby, switch off the main power switch in the back, and unplug the unit for at least thirty seconds before trying to power it up again. (*Sometimes a brownout or short-term loss of power might require a restart.*)



Important!

---

**Make sure to power down your power amplifier BEFORE doing the restart.**

---

- If none of these solutions work, please consult your Classé dealer for assistance. Never attempt to replace an internal fuse. There are no user-serviceable parts inside your unit.

### 3. Only one speaker seems to be playing.

- Check the main balance control setting of the CP-700 by pressing the **Menu** button, followed by the **balance** button (or simply press **Bal** on the remote control).
- Does the problem occur with all inputs? If so, check the interconnect cables between the preamp and the power amp. If no fault is found there, check the speaker wires for secure connections.



**Important!**

---

**Be certain that the power amplifier is off before checking any connections between the preamplifier and power amplifier, or between the speakers and the power amplifier.**

---

- If the problem occurs only with a particular input, check the input balance control setting of that particular input:

**Menu • system setup • input • *input name* • balance**

where *input* name is the particular input in question.

- If the input balance appears to be correct, check the interconnect cables between the corresponding source component and the CP-700.

### 4. The IR remote control seems not to function.

- Ensure that there are no obstacles between the IR remote and the IR sensor (located to the right of the Mute button).
- If the batteries are weak, replace them with fresh ones.

### 5. There is a hum coming out of the speakers.

- If you are running single-ended interconnects, make sure they are not running alongside any AC power cords.
- If you are running single-ended interconnects, make sure they are not too long. Long runs of single-ended interconnects have a natural tendency to pick up noise even if they are shielded.
- If any source components connected to your preamplifier has a cable TV hooked up to it, try disconnecting the cable television line from the source. If the hum goes away, you will need an isolation device between your cable and that particular source. Refer to your Classé dealer for one of these inexpensive devices.

- If you have the optional phono module in your preamplifier, make sure that the ground wire of the tonearm is secured properly to the ground lug on the back of your preamp.
- If the hum exists only on the phono input, make sure the turntable/tonearm assembly is not too close to other components. There should be at least 12 inches (30cm) clearance from the other components. The more clearance you provide, the better (as long as the tonearm cable is not stretching).
- Make sure the tonearm cable is not touching or running alongside an AC cable.
- Make sure you have the proper loading for your phono cartridge. If you are in doubt, consult your authorized Classé dealer.

**6. There is a mechanical hum coming from the unit.**

- This symptom suggests you have a lot of electrical noise on your AC mains line. Try connecting to another AC circuit (not merely a different plug, but a different circuit).
- Check to see if you have any halogen lighting or dimmers on the same circuit as the preamplifier, as they can be the cause of hum in power supply transformers.

**7. There is a noticeable change in volume between one input and another, even though the volume was not adjusted.**

- You may need to adjust the input offset setting to compensate for differences in output level between source components. Conversely, the input offset setting may have been adjusted inappropriately. Either way, you can correct the problem by going to the following location in the menu system:

**Menu • system setup • input • *input name* • offset**

where *input name* is the input which needs to be adjusted.

- If the input that seems incorrect is the phono input, make sure you are using the proper gain setting for the type of cartridge you are using. If in doubt, consult with your authorized Classé dealer.



# Care and Maintenance

## cleaning the cabinet

To remove dust from the cabinet of your preamplifier, use a feather duster or a soft, lint-free cloth. To remove dirt and fingerprints, we recommend isopropyl alcohol and a soft cloth. Dampen the cloth with alcohol first and then lightly clean the surface of the preamplifier with the cloth. Do not use excessive amounts of alcohol that might drip off the cloth and into the preamplifier.



### Caution!

---

**At no time should liquid cleaners be applied directly to the surface of the preamplifier, as direct application of liquids may result in damage to electronic components within the unit.**

---

## cleaning the LCD touchscreen

To clean the LCD touchscreen, use a microfiber eyeglass wipe or soft, lint-free cloth, together with a cleaning solution designed for plastic eyeglasses or LCD computer monitors/televisions.

### Important!

---

**Spray the solution onto the cloth or tissue – never directly onto the touch screen.**

---

## installing the remote control batteries

The battery compartment is situated at the base of the remote control. Remove the two screws holding the base plate in place, taking care not to lose them. Insert the two AA batteries (supplied), ensuring that the polarity is the same as that indicated on the inner surface of the remote control.

# Specifications

All specifications are accurate at the time of printing. Classé reserves the right to adjust specifications without notice.

■ <b>Frequency response</b>	20 Hz – 200kHz ± 0.1dB
■ <b>Distortion</b> ( <i>THD + noise</i> )	0.0012%
■ <b>Maximum input voltage</b> ( <i>single-ended</i> )	5Vrms
■ <b>Maximum input voltage</b> ( <i>balanced</i> )	10Vrms
■ <b>Maximum output voltage</b> ( <i>single-ended</i> )	10Vrms
■ <b>Maximum output voltage</b> ( <i>balanced</i> )	20Vrms
■ <b>Gain range</b>	-86dB to +14dB
■ <b>Input Impedance</b> ( <i>single ended</i> )	100kΩ
■ <b>Input Impedance</b> ( <i>balanced</i> )	200kΩ
■ <b>Output Impedance</b>	100Ω
■ <b>Maximum Input to Noise Floor</b>	120dB
■ <b>Channel separation</b>	130dB at 1kHz
■ <b>Crosstalk</b> ( <i>any input to any output</i> )	better than -120dB @ 1kHz
■ <b>Rated power consumption</b>	42W
■ <b>Idle power consumption</b>	29W
■ <b>Mains voltage</b>	determined by the needs of country for which the unit was manufactured; cannot be reset by dealer or user
■ <b>Overall dimensions (preamplifier)</b>	Width: 17.5" (445mm) Depth: 16.5" (419mm) Height: 4.75" (121mm)
■ <b>Overall dimensions (power supply)</b>	Width: 5" (127mm) Depth: 12" (305mm) Height: 5.5" (140mm)
■ <b>Net weight (preamplifier)</b>	23lbs (10.5kg)
■ <b>Net weight (power supply)</b>	10lbs (4.6kg)
■ <b>Shipping weight</b>	45lbs (20.5kg)

For more information, see your Classé dealer, or contact:

## **Classé Audio**

5070 François Cusson

Lachine, Quebec

Canada H8T 1B3

Telephone +1 (514) 636-6384

FAX +1 (514) 636-1428

Internet: <http://www.classeaudio.com>

email: [cservice@classeaudio.com](mailto:cservice@classeaudio.com)

Classé and the Classé logo are trademarks of Classé Audio Inc. of Lachine, Canada. All rights reserved.

i-Command™ is a trademark of Equity International, Inc. All rights reserved.

AMX® is a registered trademark of AMX Corporation of Richardson, TX. All rights reserved.

Crestron™ is a trademark of Crestron Electronics, Inc. of Rockleigh, NJ. All rights reserved.

# Dimensions

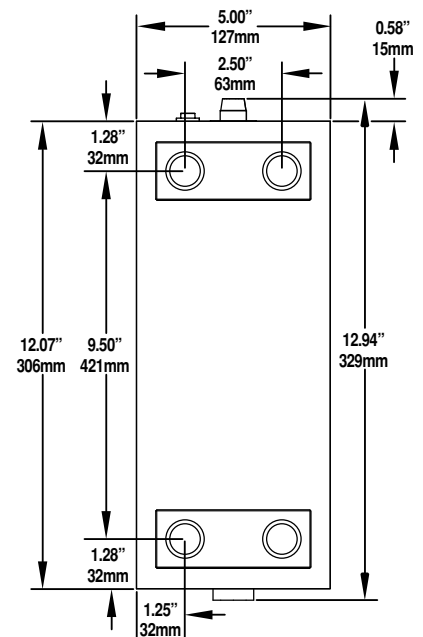
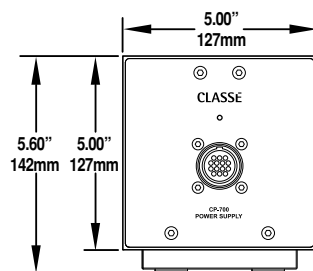
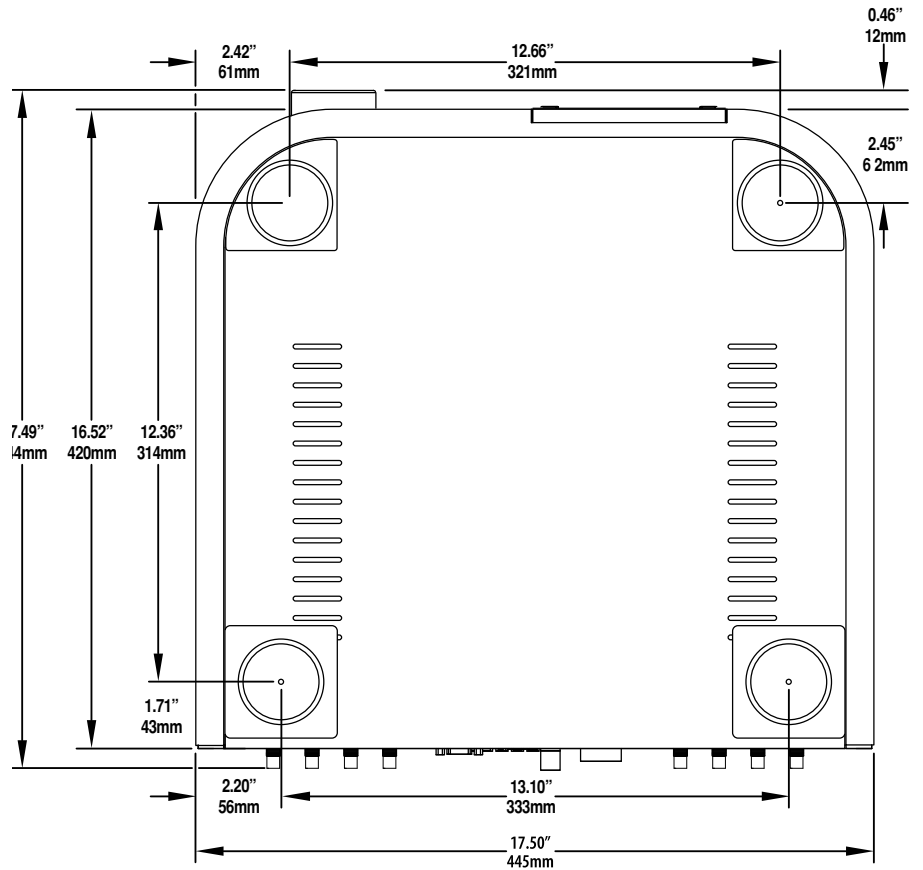
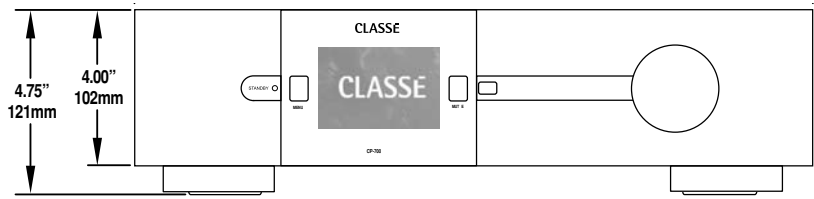

# CLASSE

## **Classé Audio**

5070 François Cusson  
Lachine, Quebec  
Canada H8T 1B3

+1 (514) 636-6384  
+1 (514) 636-1428 (fax)

<http://www.classeaudio.com>

email: [cservice@classeaudio.com](mailto:cservice@classeaudio.com)

North America: 1 800 370 3740  
email: [classe@bwgroupusa.com](mailto:classe@bwgroupusa.com)

Europe: 44 (0) 1903 221 700  
email: [classe@bwgroup.com](mailto:classe@bwgroup.com)

Asia: (852) 2790 8903  
email: [classe@bwgroup.hk](mailto:classe@bwgroup.hk)

All Others: +1 514 636 6394  
email: [cservice@classeaudio.com](mailto:cservice@classeaudio.com)