

ROTEL

Owner's Manual

RSP-976

Surround Sound Processor

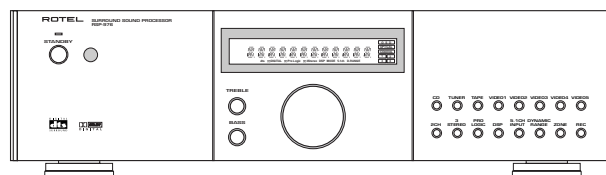

1: Controls and Connections

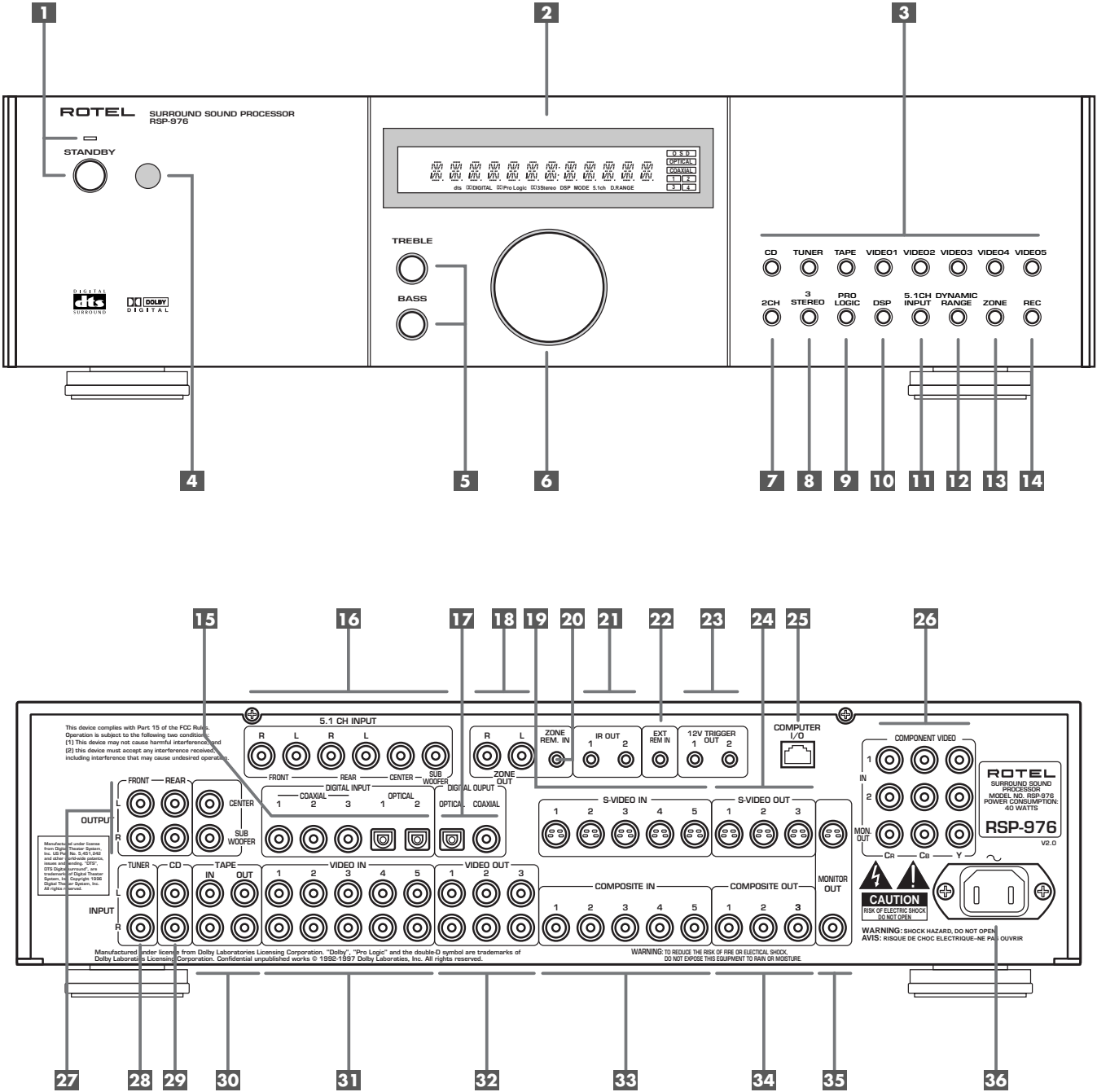

2: RR-969 Remote

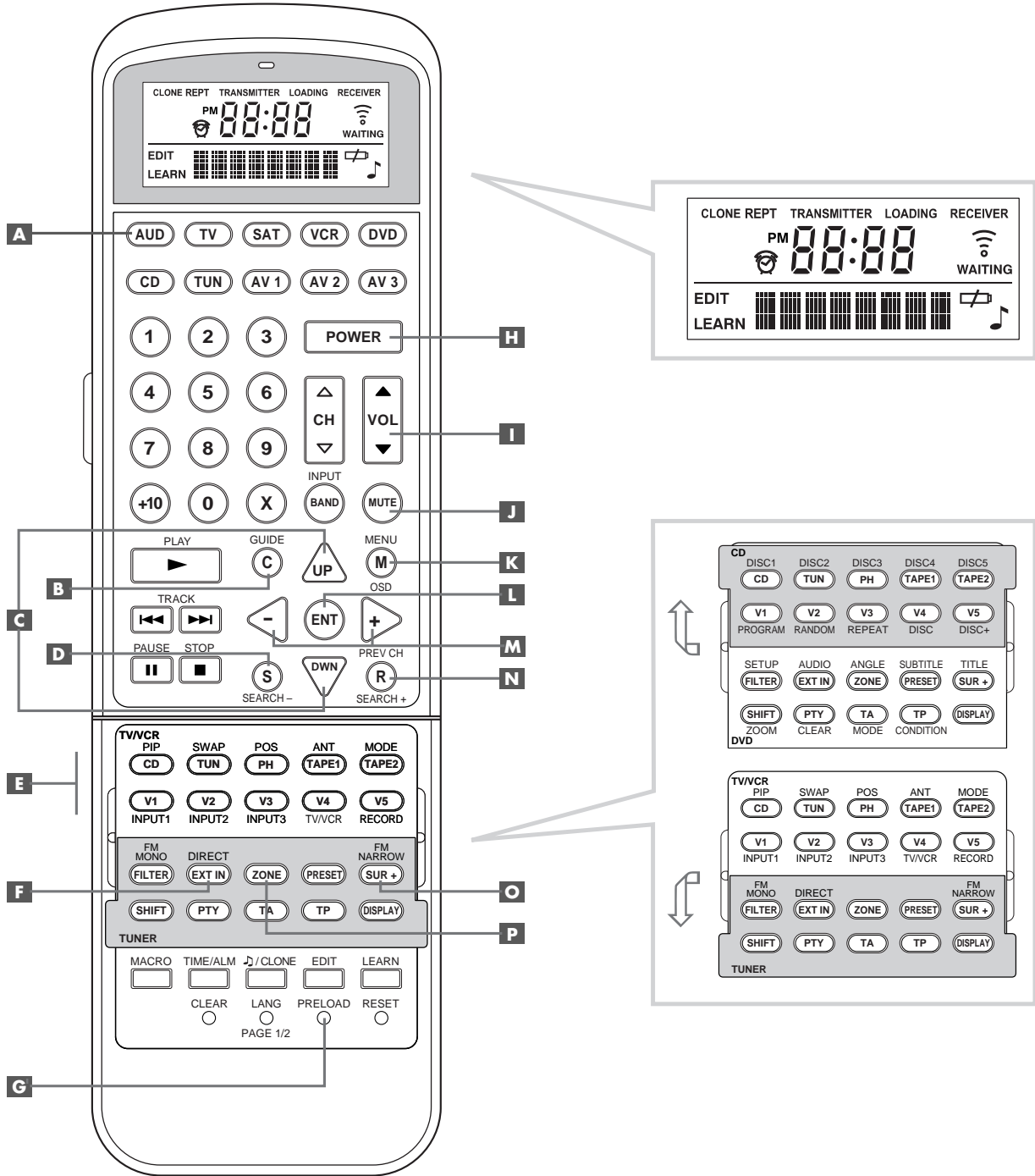

3: Outputs

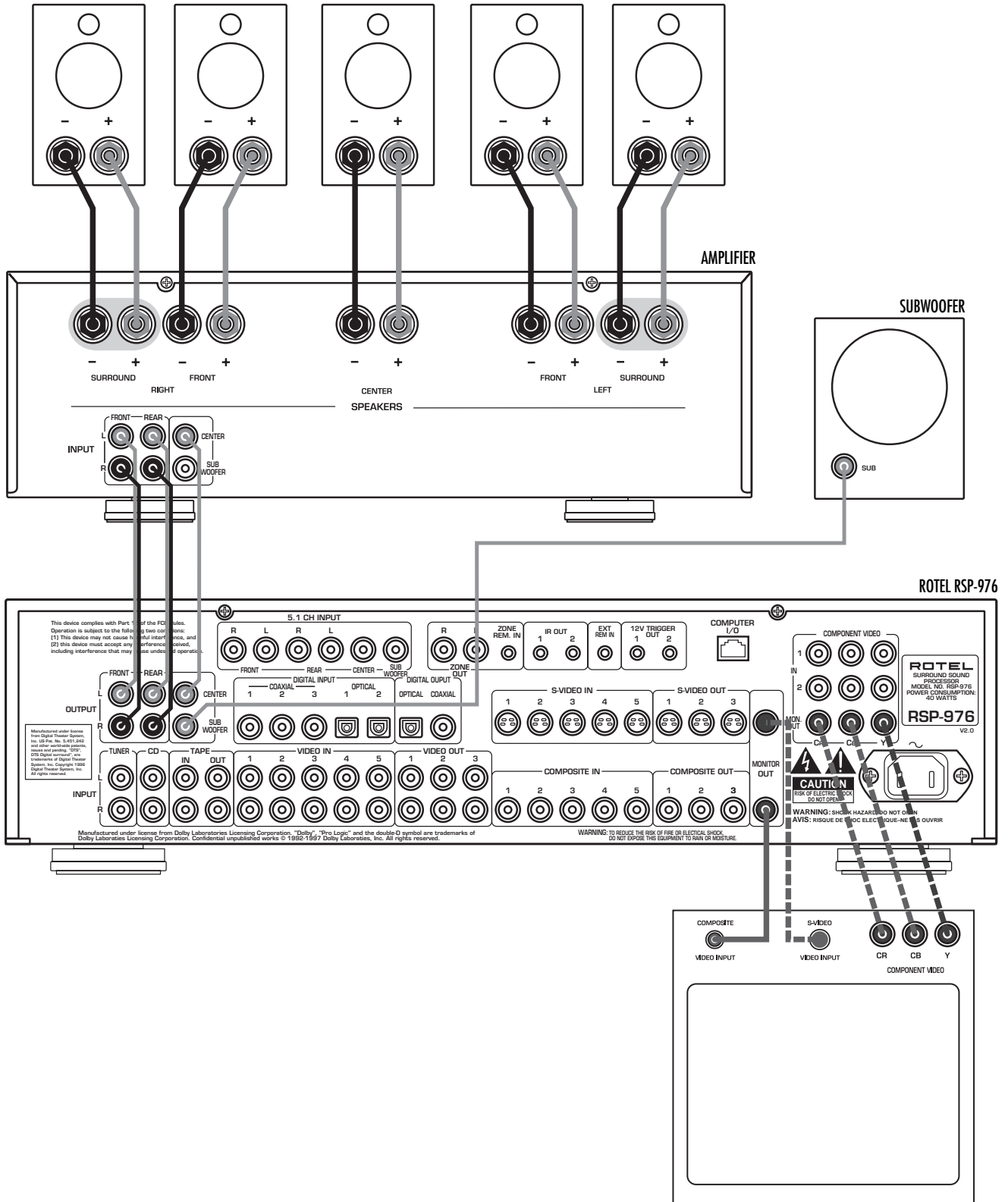

TV

4: Inputs

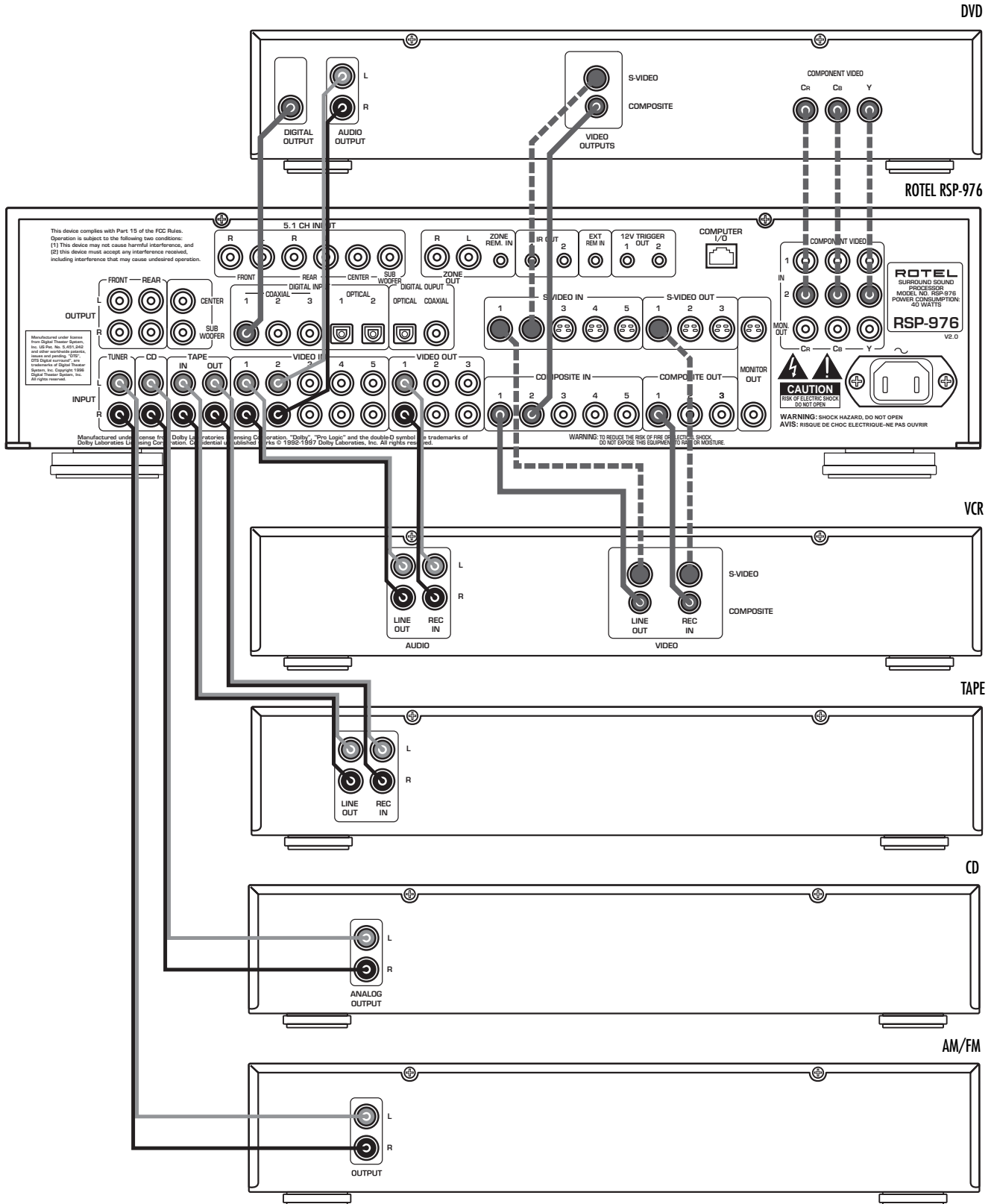

5: Zone 2 Connections

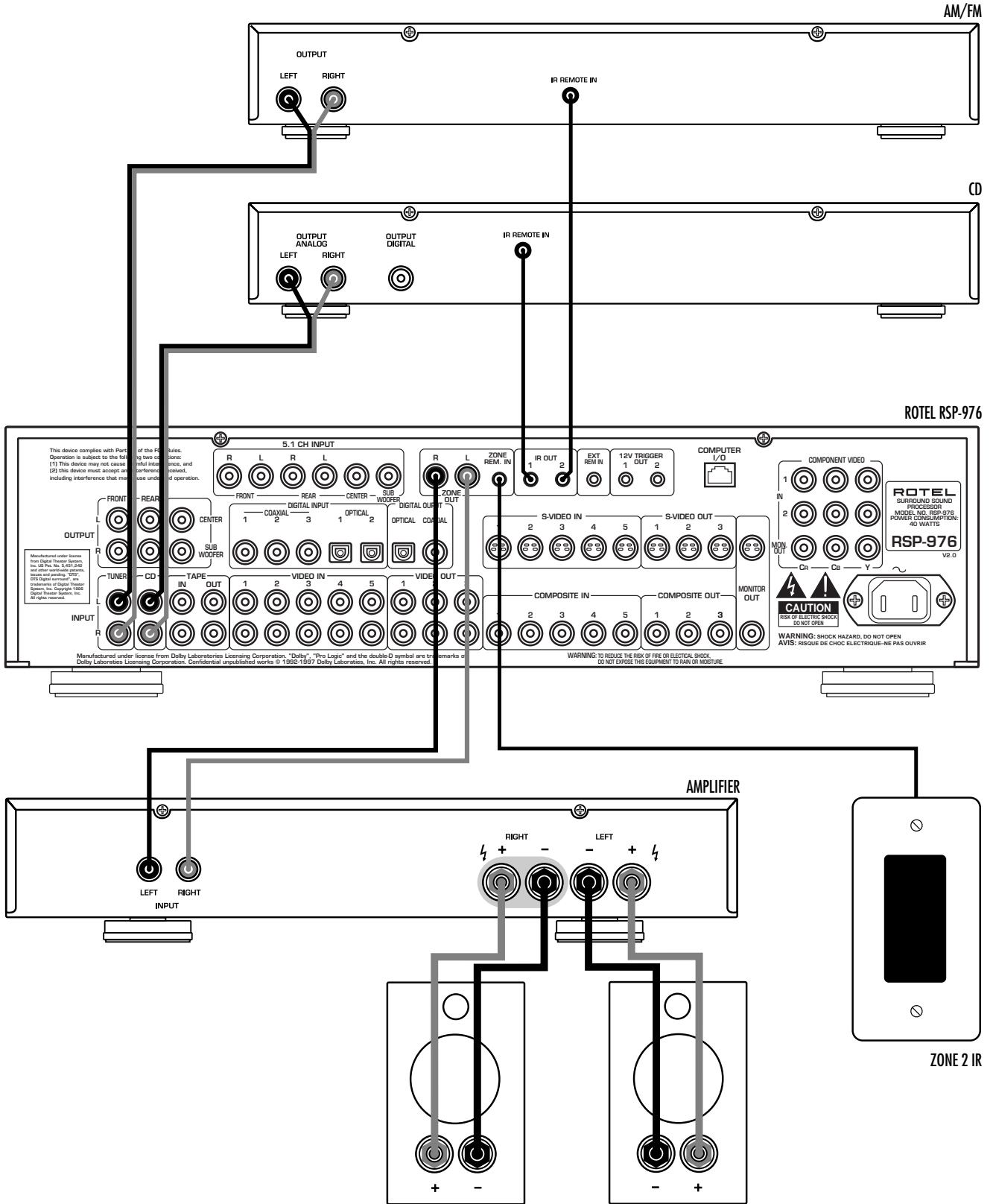

6: On-Screen Menus

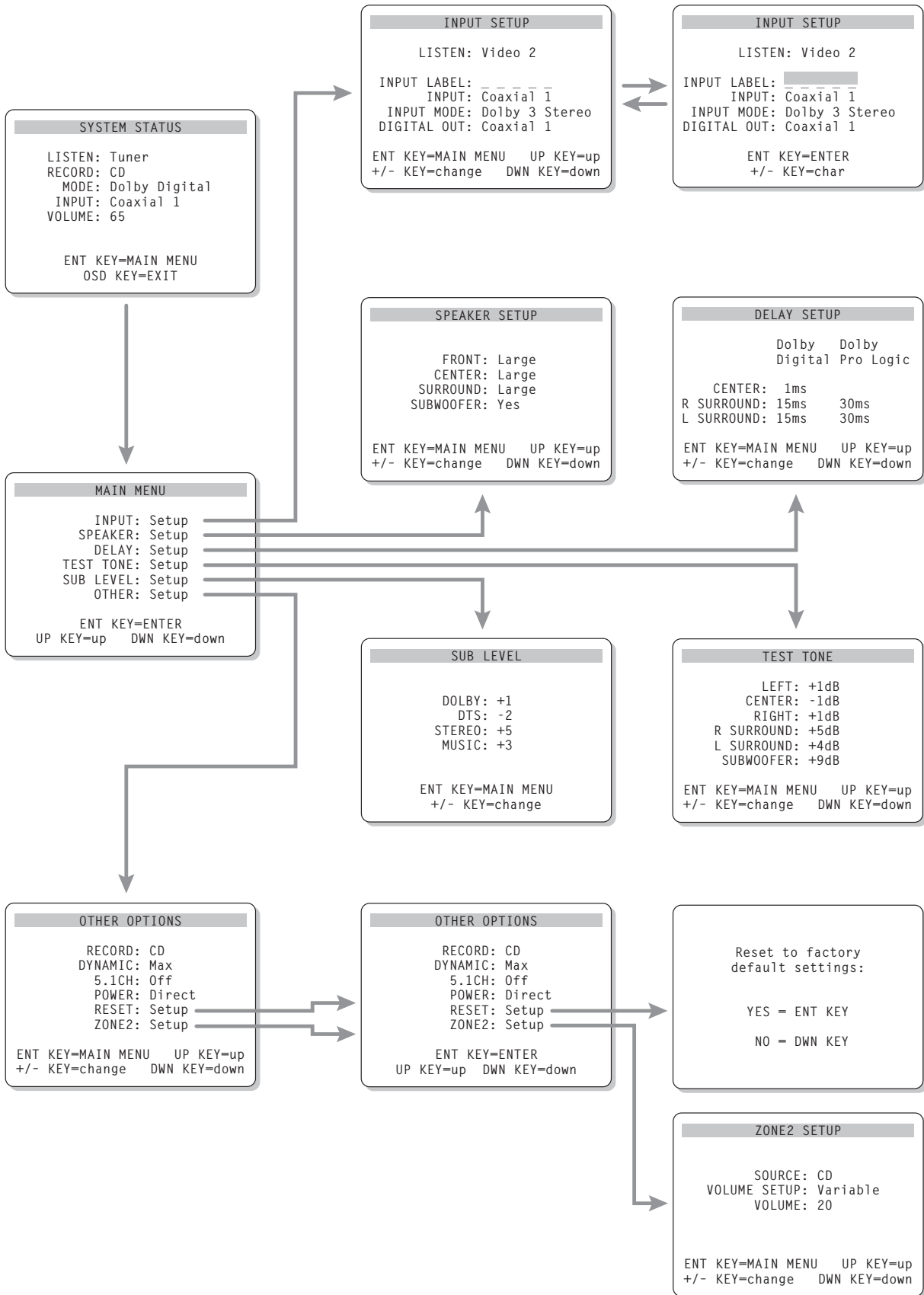

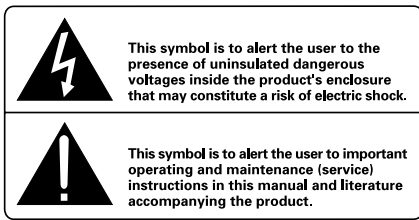
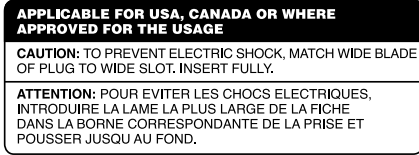

Cautions

WARNING: There are no user serviceable parts inside. Refer all servicing to qualified service personnel.

WARNING: To reduce the risk of fire or electric shock, do not expose the unit to moisture or water. Do not allow foreign objects to get into the enclosure. If the unit is exposed to moisture, or a foreign object gets into the enclosure, immediately disconnect the power cord from the wall. Take the unit to a qualified service person for inspection and necessary repairs.

Read all the instructions before connecting or operating the component. Keep this manual so you can refer to these safety instructions.

Heed all warnings and safety information in these instructions and on the product itself. Follow all operating instructions.

Clean the enclosure only with a dry cloth or a vacuum cleaner.

You must allow 10 cm or 4 inches of unobstructed clearance around the unit. Do not place the unit on a bed, sofa, rug, or similar surface that could block the ventilation openings. If the unit is placed in a bookcase or cabinet, there must be ventilation of the cabinet to allow proper cooling.

Keep the component away from radiators, heat registers, stoves, or any other appliance that produces heat.

The unit must be connected to a power supply only of the type and voltage specified on the rear panel of the unit. (USA: 115 V/60Hz, EC: 230V/50Hz)

Connect the component to the power outlet only with the supplied power supply cable or an exact equivalent. Do not modify the supplied cable in any way. Do not attempt to defeat grounding and/or polarization provisions. The cable should be connected to a 2-pin polarized wall outlet, matching the wide blade of the plug to the wide slot of the receptacle. Do not use extension cords.

Do not route the power cord where it will be crushed, pinched, bent at severe angles, exposed to heat, or damaged in any way. Pay particular attention to the power cord at the plug and where it exits the back of the unit.

The power cord should be unplugged from the wall outlet if the unit is to be left unused for a long period of time.

Immediately stop using the component and have it inspected and/or serviced by a qualified service agency if:

- The power supply cord or plug has been damaged.
- Objects have fallen or liquid has been spilled into the unit.
- The unit has been exposed to rain.
- The unit shows signs of improper operation
- The unit has been dropped or damaged in any way



Contents

Boxed numbers refer to RSP-976 illustration.
Boxed letters refer to RR-969 illustration.

1: Controls and Connections	2	Surround Sound Controls	12	Power and Miscellaneous Connections ...	15
2: RR-969 Remote	3	PRO LOGIC Button 9	12	AC Input 36	15
3: Outputs	4	3 STEREO Button 8	12	12V TRIGGER Connections 23	15
4: Inputs	5	DSP Button 10	12	EXTERNAL REM. IN 22	16
5: Zone 2 Connections	6	2CH Button 7	12	Computer I/O 25	16
6: On-Screen Menus	7	SUR+ Button 0	13	Zone 2 Connection and Operation	16
		Speaker Level Adjustment Selection Buttons B D N	13	Zone 2 Power On/Off Operation	16
		UP/DOWN Buttons C	13	Controlling Zone 2 from the Main Room ZONE Button 13	16
		DYNAMIC RANGE Button 12	13	Controlling Zone 2 from the Remote Location	17
		DWN Button C	13	Zone 2 Audio Outputs 18	17
Cautions	8	Connections: Overview	13	ZONE REM. IN Jack 20	17
About Rotel	10	Audio Source Connections	13	IR OUT Jacks 21	17
Getting Started	10	TUNER Inputs 28	13	On-Screen Display / Configuration	18
Key Features	10	CD Inputs 29	13	Navigation Buttons C K L M	18
Unpacking	10	TAPE Inputs and Outputs 30	13	SYSTEM STATUS Menu	18
Placement	10	Video Source Inputs	14	MAIN Menu	18
RR-969 Remote Control	10	VIDEO 1–5 Audio Inputs 31	14	INPUT Menu	18
Using the RR-969 A	10	VIDEO 1–5 Composite Video Inputs 33	14	SPEAKER SETUP Menu	19
Programming the RR-969 G	10	VIDEO 1–5 S-Video Inputs 19	14	DELAY SETUP Menu	20
Basic Controls	11	VIDEO 1–2 Component Video Inputs 26	14	SUBWOOFER LEVEL Menu	20
STANDBY/POWER Switch I H	11	5.1 Channel Audio Inputs 16	14	TEST TONE Menu	20
Remote Sensor 4	11	Video Source Outputs	14	OTHER OPTIONS Menu	21
Front Panel Display 2	11	VIDEO 1–3 Audio Outputs 32	14	RESET Menu	21
Volume Control 6 A I	11	VIDEO 1–3 Composite Video Outputs 34	14	ZONE 2 SETUP Menu	21
MUTE Button J	11	VIDEO 1–3 S-Video Outputs 24	15	Specifications	22
Tone Controls 5	11	Digital Source Connections	15	Audio	22
MENU Button K	11	Digital Inputs 15	15	Video	22
ENTER Button L	11	Digital Outputs 17	15	General	22
Input Controls	11	Output Signal Connections	15		
Input Source Buttons 3 E	11	TV Monitor Output 26 35	15		
REC Button 14		RCA Preamp Outputs 27	15		
ZONE Button P	12				
5.1 CH Input 11					
EXT IN F	12				

About Rotel

A family whose passionate interest in music led them to manufacture high fidelity components of uncompromising quality founded Rotel 40 years ago. Through the years that passion has remained undiminished and the family goal of providing exceptional value for audiophiles and music lovers regardless of their budget, is shared by all Rotel employees.

The engineers work as a close team, listening to, and fine tuning each new product until it reaches their exacting musical standards. They are free to choose components from around the world in order to make that product the best they can. You are likely to find capacitors from the United Kingdom and Germany, semi conductors from Japan or the United States, while toroidal power transformers are manufactured in Rotel's own factory.

Rotel's reputation for excellence has been earned through hundreds of good reviews and awards from the most respected reviewers in the industry, who listen to music every day. Their comments keep the company true to its goal - the pursuit of equipment that is musical, reliable and affordable.

All of us at Rotel, thank you for buying this product and hope it will bring you many years of enjoyment.

Getting Started

Thank you for purchasing the Rotel RSP-976 Surround Sound Processor. The RSP-976 combines a digital audio/video processor to decode Dolby® Pro Logic® analog and Dolby Digital® and DTS® digital surround sound signals with a full-featured audio/video control center for analog and digital components.

Key Features

- Rotel's Balanced Design Concept combines advanced circuit board layout, comprehensive parts evaluation, and extensive listening tests for superior sound and long term reliability.
- Dolby® Pro Logic® decoding for analog sources. Dolby Digital® and DTS® decoding for 5.1 channel digital sources
- 5.1 channel input for outboard adaptor and future upgradeability
- User friendly ON-SCREEN DISPLAY with programmable labels for video components.
- Comprehensive digital and analog input and output connections for digital signals, composite video, S-Video, and Component Video.
- Zone 2 output with independent input selection and volume adjustments for multi-zone custom installations along with IR-repeater capability for operation from the remote zone.
- Universal learning remote control to operate the RSP-976 and nine other components.
- Computer interface connection for operation from a computer running third-party audio control software.

Unpacking

Remove the unit carefully from its packing. Find the remote control and other accessories. Save the box as it will protect the RSP-976 if you move or need to return it for maintenance.

Placement

Place the RSP-976 on a solid, level surface away from sunlight, heat, moisture, or vibration.

Place the RSP-976 close to the other components in your system and, if possible, on its own shelf. This will make initial hookup, and subsequent system changes easier.

The RSP-976 can generate heat during normal operation. Do not block ventilation openings. Allow a minimum of 10 cm (4 inches) of unobstructed space around the unit. If installed in a cabinet, make sure that there is adequate ventilation.

Don't stack other components or objects on top of the RSP-976. Don't let any liquid fall into the unit.

RR-969 Remote Control

The RSP-976 includes a full-function learning remote control that can operate the RSP-976 plus nine other components.

A separate manual, included with the remote, gives detailed instructions on programming and using the RR-969 to replace all of the remote controls in your system. To avoid duplication, we provide only basic information about using the RR-969 to operate the RSP-976 in this manual.

Most of the RR-969 functions duplicate the front panel controls. For that reason, we will cover the operating controls on the remote in the appropriate sections of this manual. Letters in gray boxes next to the name of a function refers to the labeled illustration of the remote at the front of this manual.

Using the RR-969 **A**

To operate the RSP-976 with the remote, make sure that the AUDIO mode is active by pressing the AUD button **A** on the remote before you start. The AUDIO mode will stay active until another DEVICE button is pressed.

Programming the RR-969 **G**

The RR-969 is preprogrammed to operate the RSP-976. Should the AUDIO command set on your RR-969 not operate the RSP-976, the programming may have been changed. To restore the RSP-976 programming, press the recessed PRELOAD button **G** on the remote with the tip of a ballpoint pen.

NOTE: Pushing the PRELOAD button will erase all custom programming and learned commands, restoring the RR-969 to its factory condition.

Basic Controls

We suggest you look over the RSP-976's front and rear panels before you start connecting other components. The following explanations will help you get familiar with the unit's connections, features, and controls.

Most functions are duplicated on the front panel and on the remote. A few are found only on one or the other. Throughout this manual, numbers in gray boxes refer to the RSP-976 illustration at the front of this manual. Letters refer to the RR-969 remote illustration. When both appear, the function is found on both the RSP-976 and the remote. When only one appears, that function is found only on the RSP-976 or the remote.

STANDBY/POWER Switch **I H**

The STANDBY switch on the RSP-976 and the POWER switch on the remote turn the unit on or off. When turned off, minimal power is still supplied to memory circuits to preserve settings. When the unit has AC power applied, either in standby mode (OFF) or fully-activated (ON) in the main room, the front panel STANDBY LED lights.

There are three available power mode options for the RSP-976, selected during set-up from an ON-SCREEN DISPLAY menu. The default DIRECT mode fully activates the unit whenever AC power is supplied; however, the front panel STANDBY switch and remote POWER switch can still be used to turn the unit off and on. With the STANDBY power option, the unit powers up in off mode when AC is first applied and must be manually activated with the POWER or STANDBY buttons. With the ALWAYS-ON power option, the unit is fully operational whenever AC is applied and the STANDBY and POWER buttons are disabled.

When using Zone 2, the power on and off operation is completely independent for the main room and Zone 2. The front-panel STANDBY button will not affect Zone 2. Pressing the POWER button on a remote located in Zone 2 will only affect that zone and not the main room. When the unit is OFF in the main room and ON in ZONE 2, the front panel STANDBY LED flashes.

Remote Sensor **4**

This sensor receives IR signals from the remote control. Do not block this sensor.

Front Panel Display **2**

The fluorescent (FL) display in the upper portion of the RSP-976 provides status information. An alphanumeric display shows the name of the source selected for listening on the left and the source selected for recording on the right. At the bottom of the display are status indicators for surround modes and other settings. At the right side of the display are indicators including input source connections.

The FL display can be turned off by pressing and holding the MENU button **K** on the remote for three seconds. The display can be turned back on by briefly pressing the MENU button again or by pressing the POWER button on the remote or the STANDBY button on front panel.

Volume Control **6 I**

The VOLUME control adjusts the level of all output channels. Rotate the front panel control clockwise to increase the volume, counterclockwise to decrease. The RR-969 remote has VOLUME UP and DOWN buttons.

When you adjust the volume, a digital readout appears in the front panel display and the new setting appears on your TV monitor.

NOTE: *The VOLUME control can be used to change the volume in Zone 2. Press the front panel ZONE button and adjust the volume. After 10 seconds, the VOLUME control reverts to normal operation.*

MUTE Button **J**

Push the MUTE button once to turn the sound off. An indication appears in the front panel and on-screen displays. Press the button again to restore previous volume levels.

Tone Controls **5**

BASS and TREBLE controls increase or decrease the audio signal's low and high frequency content respectively. Rotate clockwise to increase output and counterclockwise to reduce. The front panel display and ON-SCREEN DISPLAY show tone control settings as you adjust them.

MENU Button **K**

Push this button on the remote to turn on the ON-SCREEN DISPLAY menu system. If the menu system is already visible, push this button to cancel the display.

The MENU button can also be used to turn on and off the front panel FL display. Press and hold the MENU button on the remote for three seconds to turn off the front panel display. Briefly press the MENU button again to turn the display back on. The display also turns back on whenever the STANDBY or POWER buttons are pressed.

ENTER Button **L**

The ENTER button is used to confirm and memorize various settings in the setup and operation of the RSP-976. Its use is described in detail in the relevant sections.

Input Controls

Input Source Buttons **3 E**

Press any of the eight front panel buttons to select an audio or video input source (CD, tuner, VCR, etc.) for listening. You will hear this source and, if you have selected a video source, see its picture on your TV monitor.

The front panel display and the ON-SCREEN DISPLAY will show the name of the current listening source selection. The labels for VIDEO sources can be customized to match your components.

All of the inputs (the five video inputs, the tuner input, the CD input, and the TAPE input) can accept either analog signals or digital signals from one of the five assignable digital inputs.

By default, the source input buttons are configured to select the analog input when pressed. However, each source input button can be configured using the ON-SCREEN DISPLAY menu system to give priority to the digital signal. Then, a signal present at the assigned digital input when the source is selected is automatically activated and the proper surround mode enabled. If no digital signal is present, the analog inputs are selected. This auto-sensing is the preferred configuration for digital source inputs such as DVD players. See the INPUT MENU section for configuration instructions.

The input source buttons can also be used (in conjunction with the REC button described in the next section) to select an analog input source signal to be available at the outputs for recording. Additionally, the input source buttons can be used with the ZONE button to select an analog input source for ZONE 2.

REC Button **14** ZONE Button **P**

The RSP-976 can record from any analog source input to a VCR or other recorder connected to the VIDEO 1, 2 or 3 outputs or the TAPE outputs, even while you are listening to a different input source. To select an input source for recording, press the REC button on the front panel (or the equivalent ZONE button on the remote). Then, press one of the INPUT SOURCE buttons within 5 seconds to select the signal you wish to record. After making your selection (or if more than five seconds passes), the input source buttons return to their normal function, selecting a listening source.

Remember, this selection is independent of the listening source. While recording, you may still select a different source (for example, the CD input) for listening. The record selection appears in the display to the right of the listening selection.

NOTE: The RECORD function requires analog signals. If you use a digital connection from a CD player or DVD for listening, you should also connect an analog signal for recording.

5.1 CH Input **11** EXT IN **F**

The 5.1 CH button (or the EXT IN button on the remote) overrides all other inputs (both analog and digital) and connects an external digital adaptor to the RSP-976's outputs. This provides an upgrade path to future software standards. When activated, the RSP-976's digital processing is bypassed. An indicator appears in the front panel display.

Surround Sound Controls

The RSP-976 decodes Dolby® Pro Logic®, Dolby Digital®, and DTS® surround sound source material as well as providing several DSP ambience simulations for music.

Dolby Digital and DTS decoding of digital signals is automatic. When a digital signal encoded with either of these is detected, the RSP-976 activates the proper decoding. In most cases, the RSP-976 will also recognize a digital signal encoded with Dolby Pro Logic for processing. Additionally, you can configure a default surround mode for each input using the ON-SCREEN DISPLAY menu system.

Four buttons allow manual control of the surround sound/ambience settings, overriding any configured default setting or auto-sensing. There are no right or wrong settings. Just because a mode is labelled 2 CHANNEL does not mean that you must use this mode every time you play a stereo CD. You may prefer one of the other surround modes.

As a general rule, we recommend using PRO LOGIC mode for all sources labeled Dolby Pro Logic. Beyond that, use whatever settings sound best to you in your room with your system.

PRO LOGIC Button **9**

This setting decodes Dolby Pro Logic encoded surround sound material, whether it be a music CD, videotape, videodisc, stereo TV broadcast, or radio broadcast. It also can be used to create additional ambience in 2-channel musical source material. Front, center, and rear speakers are activated. An indicator lights in the front panel display when the PRO LOGIC button is pressed.

NOTE: Leaving the RSP-976 in PRO LOGIC mode offers satisfactory performance and convenience for many source materials. It provides automatic decoding of analog surround sound material and automatic selection of digital processing when a Dolby Digital or DTS source is played.

3 STEREO Button **8**

This mode provides proper playback of Dolby Pro Logic material on systems that have front and center speakers, but lack rear surround speakers. It adds the rear channel signals to the front speakers for a larger, more ambient sound than conventional stereo. An indicator lights in the front panel display to show that this mode has been activated.

DSP Button **10**

This button activates digital synthesis of four ambience modes (MUSIC 1, MUSIC 2, MUSIC 3, and MUSIC 4) which simulate progressively larger acoustic environments and are used to recreate ambience when listening to music sources and/or other sources that lack surround sound encoding.

These four modes vary the amount of delay used for the rear surround signals. Experiment to find a setting which is most pleasing.

Press the button to activate the DSP mode. Each press of the button will step forward to the next mode in the following order: MUSIC 1 > MUSIC 2 > MUSIC 3 > MUSIC 4. An indicator lights in the front panel display when DSP mode has been activated.

NOTE: As a general rule, the DSP modes provide more exaggerated ambience effects than the PRO LOGIC mode. Experiment with the more spectacular DSP modes for particular recordings or effects.

2CH Button **7**

This button activates conventional 2-speaker stereo mode with no surround sound or other processing. This is "pure" stereo, using the front left and front right speakers (with or without subwoofer), with no surround channels and no center channel.

When used with Dolby Digital or DTS source material, the 2CH button engages a downmix feature, combining all of the channels and sending them to the front speakers. The spatial effects of surround sound are lost, but all of the information on the original recording are preserved.





NOTE: 2CH mode allows you to hear 2-channel stereo recordings in their original format.

SUR+ Button

The SUR+ button on the remote selects the surround modes described above. Each time you press the button, the surround mode will cycle to the next available setting as indicated by the front-panel display. Repeatedly press the button until you reach the desired setting.

Speaker Level Adjustment Selection Buttons UP/DOWN Buttons

The relative volume levels of all six channels should be calibrated using test tones with an ON-SCREEN DISPLAY menu during the initial setup of the RSP-976. You can also adjust the relative volume of the center, rear, or subwoofer channels using buttons on the remote control:

1. Press one of the selection buttons on the remote to select a channel (or pair of channels) for adjustment. Press the C button  to adjust the CENTER channel. Press the S button  to adjust the SUBWOOFER channel. Press the R button  to adjust the rear SURROUND channels.
2. Use the UP or DOWN buttons  on the remote to adjust the output level of the selected channel(s).
3. Repeat the procedure for each channel.

If no level adjustment is made for 5 seconds after pressing one of the selection buttons, the levels revert to the default calibrated settings.

NOTE: The ON-SCREEN DISPLAY calibration procedure permits independent adjustment of each rear surround channel. The adjustment procedure described here only allows changing the relative volume of both surround channels in unison.

DYNAMIC RANGE Button DWN Button

Digital sources are capable of wide dynamic range (the difference between the softest and loudest sounds). In some cases, this may tax amplifiers and/or speakers. In other cases, you may want to reduce the dynamic range when listening at low volume levels. Pressing the front-panel DYNAMIC RANGE button (or the DWN button on the remote) steps through the three dynamic range settings:

- MAX (no compression/full dynamic range)
- MID (moderate compression)
- MIN (full compression/minimum dynamic range).

A "D. RANGE" indicator in the front-panel display lights when the dynamic range is not set to the MAX setting.

NOTE: The DYNAMIC RANGE feature is only available in Dolby Digital mode. It is inactive at all other times.

Connections: Overview

The RSP-976 rear panel connections include standard RCA audio inputs and outputs, composite video inputs and outputs, S-Video inputs and outputs, Component Video inputs, plus coaxial and optical digital inputs and outputs.

The RSP-976 has RCA preamp audio outputs for use with external amplifiers as well as composite video, S-Video, and Component Video outputs to connect your TV monitor.

The RSP-976 also has 5.1 channel input connections, a remote IR sensor input, and two 12V trigger connections for remote turn-on of Rotel amplifiers.

NOTE: Do **not** plug any system component into an AC source until all connections have been properly made.

Video cables should have a 75 ohm impedance rating. The S/PDIF digital audio interface standard also specifies a 75 ohm impedance and all good digital cables adhere to this requirement. Because the video and S/PDIF standards are so close, you can use a video cable for digital audio data transmission. We strongly advise that you NOT substitute conventional audio interconnect cables

for digital or video signals. Standard audio interconnects will pass these signals, but their limited bandwidth reduce performance.

When making signal connections, connect LEFT channels to LEFT channel jacks and RIGHT channels to RIGHT channel jacks. All RCA-type connections on the RSP-976 follow these standard color codes:

Left channel audio: white RCA jack

Right channel audio: red RCA jack

Composite video: yellow RCA jack

NOTE: Each source input must be properly configured using the INPUT MENU of the ON-SCREEN DISPLAY system. We recommend going to this menu after connecting each source to configure it as desired. See the INPUT MENU section for information.

Audio Source Connections

Connect your audio-only source components to these RCA inputs and outputs:

TUNER Inputs

Connect the left and right analog outputs from your tuner to the RCA input jacks labeled TUNER.

CD Inputs

Connect the left and right analog outputs from your CD player to the input jacks labeled CD.

TAPE Inputs and Outputs

The RSP-976 provides a pair of inputs and a pair of record outputs for connecting an analog audio tape deck.

The analog source signal available for recording at the TAPE outputs is selected with the REC button on the front panel (or the ZONE button on the remote) and its label appears in the display. If the TAPE input signal is selected as the recording source, its signal will not be available at the TAPE output, but will be available at the VIDEO outputs for recording.

Connect the left and right analog *outputs* from an audio tape deck to the TAPE IN jacks. Connect the TAPE OUT jacks to the *inputs* on the audio tape deck.

Video Source Inputs

There are input connections for five video source components. Each of the five provides a pair of RCA inputs for analog audio signals. Each of the five also provides a choice of an RCA composite video input or S-Video input for the video signal from the source component. In addition, two of the video source inputs (Video 1 and Video 2) also feature Component Video input connections as an alternative to the composite video or S-Video connections.

NOTE: *There is no need to use more than one type of video connection from a source component, although doing so will cause no harm to the unit. If you make multiple connections to a single source (i.e. RCA composite and S-Video), the RSP-976 will give priority to the S-Video connection and use that signal. As a general rule, we recommend using S-Video connections whenever possible.*

There are also video record outputs (described in a following section) which correspond to three of the video source inputs – Video 1, 2, and 3). For this reason, you should plan ahead and designate each source component as Video 1, Video 2, etc. All connections (both input and output) from a source component must be made consistently to the same set of connections. For example, **all** input and output connections to a particular VCR could be made to Video 1 connectors.

Also, be sure that the channels are connected consistently, i.e. left channel signals connected to left channel inputs/outputs and right channel signals connected to right channel inputs/outputs.

NOTE: *These video source inputs can also be used for additional audio-only sources, omitting the video signal connections.*

VIDEO 1–5 Audio Inputs 31

Using standard audio interconnect cables, connect the left and right channel analog *outputs* of VCRs or other source components to the VIDEO 1, 2, 3, 4, or 5 *inputs* using standard RCA audio cables.

VIDEO 1–5 Composite Video Inputs 33

If you use the RCA composite video connections for a source component, connect the RCA video *output* of the source component to one of the video *inputs* labeled COMPOSITE IN. Use a standard 75 ohm video cable.

VIDEO 1–5 S-Video Inputs 19

S-Video signals use a special cable which divides the video signal into several elements carried by separate conductors, providing higher quality than the standard RCA composite cables. If you choose to use an S-Video input connection from a source component, connect the S-Video *output* of that component to one of the *inputs* on the RSP-976 labeled S-VIDEO IN using a standard S-Video interconnect cable.

VIDEO 1–2 Component Video Inputs 26

Component Video connections split the video into three signals – luminance (Y) and separate chrominance (CB and CR) elements, allowing delivery of a reference-quality picture. Each of these signals is carried by a separate 75 ohm video cable with RCA connectors.

The VIDEO 1 and VIDEO 2 source inputs provide an option for using Component Video connections. If you choose to use Component Video input connection from a source component, connect the three Component Video *outputs* of that component to the corresponding *inputs* on the RSP-976 labeled COMPONENT VIDEO IN. Make sure that you connect each of the three cables to the proper connector (Y to Y, CB to CB, and CR to CR) and that you use standard 75 ohm video interconnect cables.

5.1 Channel Audio Inputs 16

A set of RCA inputs accepts six channels of analog signals from a 5.1 channel processor or source component. When selected with the front-panel 5.1CH button or remote EXT IN button, this input overrides any other audio input signal.

Use audio interconnect cables to connect the six outputs of the source component to the RCA jacks labeled 5.1 CH INPUT, making sure that you observe proper channel consistency, i.e. connect the right front channel to the R FRONT input, etc. You will make six connections (FRONT RIGHT/FRONT LEFT/REAR RIGHT/REAR LEFT/CENTER/SUBWOOFER).

Video Source Outputs

Three of the available video sources (VIDEO 1, 2 and 3) feature outputs that allow you to send a signal to a VCR or other source component for recording. The recording signal available at all of these outputs is selected globally using the REC button on the front panel or the ZONE button on the remote and is independent of the source selected for listening.

NOTE: *Recording signals are available at all source outputs, including the source selected for recording. As a general rule, you should not attempt record to the component whose signal has been selected for recording.*

The record outputs for VIDEO 1, 2, and 3 include a pair of RCA analog audio outputs plus a choice of composite video or S-Video output. To hook up a video component for recording, you will need to connect it to both analog audio outputs and to your choice of video outputs.

NOTE: *All connections (both input and output) from a source component be made consistently to the same set of connections. For example, if you designate a VCR as VIDEO 1, you must connect all of its input and output signals to the VIDEO 1 connectors.*

VIDEO 1–3 Audio Outputs 32

Using standard audio interconnect cables, connect the left and right channel RCA audio *outputs* from the RSP-976 to the audio *inputs* on the source component. Make sure that you are consistent. If you hook up a VCR to the VIDEO 1 inputs, hook up the VIDEO 1 outputs to the same VCR. Also make sure that the Left channel is connected to the LEFT connectors and the right channel to the RIGHT connectors.

VIDEO 1–3 Composite Video Outputs 34

If you choose to use the RCA composite video connections for a source component, use a 75 ohm video interconnect cable to connect the RSP-976's RCA video *output* (labeled COMPOSITE OUT) to the RCA video *input* on your VCR.

VIDEO 1-3 S-Video Outputs 24

If you choose to use S-Video connections for a source component, use an S-Video cable to connect the RSP-976's S-Video output (labeled S-VIDEO OUT) to the S-Video input on your source component.

Digital Source Connections

The RSP-976 provides digital connections which may be used in place of, or in addition to, the analog audio input and output connections described in the previous sections. These connections include five digital inputs and a digital output for recording.

These digital connections can be used with any source component that supplies a digital signal, such as a DVD player or CD player.

NOTE: A digital connection means that the D/A converters in the RSP-976 will be used to decode the digital signal, rather than the source component's internal D/A converters. In general, you would use digital connections for a DVD player or other component that supplies a Dolby Digital or DTS signal. However, if you are connecting a high-end Rotel CD player with sophisticated internal D/A converters, you might prefer to use analog audio connections to the RSP-976.

Digital Inputs 15

The RSP-976 accepts digital input signals from source components such as CD players, satellite TV receivers, and 5.1 channel Dolby Digital or DTS signals from DVD players. The built-in D/A converter senses and adjusts to the correct sampling rates.

There are five digital inputs on the rear panel, three coaxial and two optical. These digital inputs can be assigned to any of the input sources using the INPUT MENU screen described later in this manual. For example, you can assign the COAXIAL 1 digital input connector to the VIDEO 1 source and the OPTICAL 2 digital input to the VIDEO 3 source.

Connect the appropriate cable (optical or 75 ohm coaxial) from the digital output of your source component to a digital input on the RSP-976 and then configure that digital input for use with the source component using the INPUT MENU.

NOTE: When using digital connections, you should also make the analog audio input connections described previously. The analog connection is necessary to record to an analog recorder or for ZONE 2 operation

Digital Outputs 17

The RSP-976 has a digital output (with a choice of coaxial or optical connectors) to send the digital signal from any of the five digital inputs to a digital recorder or outboard digital processor. The selection of a digital input for recording is made using the ON-SCREEN DISPLAY menu system.

NOTE: Only digital signals from source components are available at these outputs. Analog signals cannot be converted and are not available at the digital outputs.

Connect the digital output to the digital input of your recorder or processor. You can use either a 75 ohm coaxial video cable or an optical cable, choosing between the two connectors using the INPUT MENU described later in this manual.

Output Signal Connections

This section of the manual describes the audio and video signal output connections on the RSP-976. These are used for routing the output signals to television monitors, audio amplifiers, and recording devices.

TV Monitor Output 26 35

The video output of the RSP-976 sends the video signal to your TV monitor. Three types of video output connections are provided – RCA composite video, S-Video, and Component Video. Choose the type of video output connection that best matches the inputs on your TV monitor. Connect the TV MONITOR output, from either RCA composite or S-Video or Component Video connector, to the corresponding input on your television monitor, using appropriate video cables.

RCA Preamp Outputs 27

There are six RCA preamp audio outputs (FRONT LEFT/FRONT RIGHT/CENTER/RIGHT REAR/LEFT REAR/SUB) for sending the RSP-976's output signals to amplifiers or powered speakers.

To hook up a powered subwoofer, connect a standard RCA audio cable from the SUBWOOFER OUTPUT jack to the input on the subwoofer's power amp.

To hook up the RCA main audio outputs, connect an audio cable from each output to the input of the amplifier channel that will power the corresponding speaker. In a full home theater system, you will need to make six different connections corresponding to the six speakers (left front, center front, right front, left surround, right surround, and subwoofer).

Make sure that you have each output connected to the correct amplifier channel (front right, left rear, etc.).

Power and Miscellaneous Connections

AC Input 36

Your RSP-976 is configured at the factory for the proper AC line voltage in the country where you purchased it (USA: 115 volts/60Hz AC or CE: 230 volts /50 Hz AC). The AC line configuration is noted on a decal on the back of your unit.

Plug the supplied cord into the AC INPUT receptacle on the back of the unit.

NOTE: Memorized settings and video labels will be stored for up to one month if the RSP-976 is disconnected from AC power.

12V TRIGGER Connections 23

Several Rotel amplifiers offer the option of turning them on and off using a 12 volt trigger signal. These two connections provide this 12 volt trigger signal. When the RSP-976 is activated, a 12 volt DC signal appears at these connectors and will turn on amplifiers. When the RSP-976 is put in STANDBY mode, the trigger signal is interrupted and the amplifiers will turn off.

EXTERNAL REM. IN

This 3.5 mm mini-jack (labeled EXT REM IN) receives command codes from an industry-standard infrared receivers (Xantech, etc.) located in the main listening room. This feature is useful when the unit is installed in a cabinet and the front-panel sensor is blocked. Consult your authorized Rotel dealer for information on external receivers and the proper wiring of a jack to fit the mini-jack receptacle.

NOTE: The IR signals from the EXTERNAL REMOTE IN jack (as well as those from the ZONE REMOTE IN jack) can be relayed to source components using external IR emitters or hardwired connections from the IR OUT jacks. See the ZONE 2 section of this manual for additional information.

Computer I/O

The RSP-976 can be operated from a personal computer running audio system control software from third-party developers. This control is accomplished by sending the operating codes normally sent by the RR-969 remote control over a hard-wired network connection from the computer.

The COMPUTER I/O input provides the necessary connection on the back panel. It accepts standard RJ-45 8-pin modular plugs, such as those commonly used in 10-BaseT UTP Ethernet cabling.

For additional information on the connections, software, and operating codes for computer control of the RSP-976, contact your authorized Rotel dealer.

Zone 2 Connection and Operation

The RSP-976 provides Zone 2 multi-room capability, allowing you to enjoy music and operate the system from a second room. From the remote location, you can select a source component (even if different from the source playing in the main listening room), adjust the volume level in the remote zone, and operate the source components.

To use the Zone 2 capability, you need additional components: a pair of speakers installed in the remote zone, an amplifier to drive them, and a third-party IR repeater system.

Zone 2 can be controlled from the main room using RSP-976's front-panel ZONE button. Operation from the remote zone requires the installation of an infrared repeater system (Xantech, Niles, etc.) which relays infrared remote control commands from Zone 2 to the ZONE REMOTE IN input on the back of the RSP-976. Using external IR emitters or hardwired IR connections, you can also operate source components by remote control from Zone 2.

Several points to keep in mind about the Zone 2 function:

- An infrared repeater system (Xantech, Niles, et al) is required for operation from the remote zone.
- There are two options for the Zone 2 output level, selectable from the ON-SCREEN DISPLAY menu system. VARIABLE output gives you full adjustment of the volume level, remembering last previous setting whenever Zone 2 is activated. FIXED output disables the Zone 2 volume control with the output permanently set to a specified level. This might be useful for sending a line level signal to a preamp or integrated amp with its own volume control or to a distribution amplifier with multiple autoformer-type volume controls.
- The RR-969 remote control supplied with the RSP-976 will operate Zone 2 if used with a repeater system from the remote zone. It can also be programmed to operate Rotel source components via the RSP-976's IR OUT jack.
- Any source component connected to the RSP-976's analog inputs (except the 5.1 CH input) can be sent to the Zone 2 outputs. ZONE 2 operates independently of the main room. You can select a different source or adjust Zone 2 volume without affecting the MAIN outputs in any way.
- Avoid sending the same infrared command to the RSP-976 front panel sensor and a Zone 2 repeater at the **same** time. This means that Zone 2 **must** be in a different room from the RSP-976.

Zone 2 Power On/Off Operation

The RSP-976 provides totally independent power on/off operation for both zones. Pressing the STANDBY button on the front panel or from the remote in the main room activates or deactivates the RSP-976 in the main room only and has no effect on Zone 2. Conversely, activating or deactivating Zone 2 has no effect on the main listening room.

NOTE: For proper power on and off operation with Zone 2, the RSP-976's power mode should be set to the factory default DIRECT setting or to the STANDBY setting using the OTHER OPTIONS menu from the ON-SCREEN DISPLAY.

Controlling Zone 2 from the Main Room ZONE Button

When the RSP-976 is powered on in the main room, you can control Zone 2 from the front panel of the RSP-976 – activate or deactivate Zone 2, change input sources, and adjust the volume. Controlling Zone 2 from the front panel is accomplished by pressing the ZONE button, which temporarily puts the RSP-976 in Zone 2 control mode.

NOTE: Zone 2 cannot be controlled from the remote in the main room.

To turn Zone 2 on or off:

1. Press the front panel ZONE button. The status of Zone 2 appears in the display. If Zone 2 is in standby, "ZONE OFF" appears. If Zone 2 is active, "ZONE xxxxx" showing the current input source appears.
2. If Zone 2 is ON, pressing the ZONE button a second time within 10 seconds turns it OFF. If Zone 2 is OFF, the second press of the ZONE button turns it ON with the last used input source and volume setting.
3. Following 10 seconds with no commands, the RSP-976 reverts to normal operation.

To change the Zone 2 input source:

1. Press the front panel ZONE button. The status of Zone 2 appears in the display. Make sure that Zone 2 is ON.
2. Within 10 seconds after pressing the ZONE button, press one of the INPUT SOURCE buttons to select a new source for Zone 2. The name of the selected source appears in the display.
3. Following 10 seconds with no commands, the RSP-976 reverts to normal operation.

To change the Zone 2 volume:

1. Press the front panel ZONE button. The status of Zone 2 appears in the display. Make sure that Zone 2 is ON.
2. Within 10 seconds after pressing the ZONE button, adjust the volume control to change the Zone 2 output level. The new setting appears in the display. This volume adjustment is only available using the VARIABLE output configuration. In FIXED output mode, the volume control for Zone 2 is disabled.
3. Following 10 seconds with no commands, the RSP-976 reverts to normal operation.

NOTE: The volume and input source controls described in this section are **only** available when the RSP-976 is fully activated in the main room (i.e. the display is visible). If the RSP-976 is turned off, you can only turn Zone 2 on or off from the front panel. In this case, the ZONE button is a simple toggle control – turning Zone 2 on or off with each press of the button. When Zone 2 is on, the front panel STANDBY LED flashes. When Zone 2 is off, the STANDBY LED is steadily lit.

Controlling Zone 2 from the Remote Location

With a properly configured IR repeater system, you have full control of Zone 2 using an RR-969 remote from the Zone 2 location. You can select and operate a source, adjust the volume, and turn Zone 2 on or off. Whatever commands you send from the RR-969 will change Zone 2 and only Zone 2, just as if you were controlling a totally independent audio system in that room. These changes will have no effect on the main listening room.

To turn Zone 2 on or off, press the POWER button **1** on the remote. To adjust the volume in Zone 2, press the VOLUME buttons **1** on the remote. To select a different analog input source, press one of the INPUT SOURCE buttons **1** on the remote.

NOTE: The volume adjustment is only available if the Zone 2 outputs are configured to use VARIABLE levels. With FIXED levels, the volume control for Zone 2 is disabled.

Zone 2 Audio Outputs **13**

See Figure 5

These line-level RCA outputs send the Zone 2 audio signal to a stereo amplifier driving a pair of speakers in the remote zone.

Although you have the option of using an integrated amplifier or a receiver to power the remote speakers, we suggest using a fixed-gain power amplifier. This simplifies system installation and operation. Your authorized Rotel dealer may make another recommendation based on specific system requirements.

To configure your system for Zone 2 operation, connect the left and right Zone 2 outputs on the RSP-976 to the left and right channel inputs of the amplifier powering the remote speakers, using standard RCA audio cables.

NOTE: By default, the Zone 2 outputs provide a VARIABLE level signal, with control of the volume from the RSP-976 front panel and/or remote control from Zone 2. Alternatively, you can configure these outputs for FIXED level, which disables the volume control and sends a fixed line-level signal to an amplifier with its own volume control. See the ON-SCREEN DISPLAY/Configuration section for details.

ZONE REM. IN Jack **20**

See Figure 5

This 3.5 mm mini-jack accepts signals from a infrared repeater located in Zone 2. A third-party IR repeater system is required for operation of the RSP-976's ZONE 2 functions from the remote zone.

NOTE: ZONE 2 and its IR repeater must be in a different location than RSP-976 to prevent IR commands intended to control Zone 2 from inadvertently controlling the main room operations.

IR OUT Jacks **21**

See Figure 5

The IR OUT 1 & 2 jacks send IR signals received at the ZONE REM IN jack or the EXTERNAL REM IN jack to an infrared emitter placed in front of a source component or to Rotel CD players, cassette decks, or tuners with a compatible rear panel IR connector.

This output is used to allow IR signals from Zone 2 to be sent to the source components, or to pass along IR signals from a remote in the main room when the sensors on the source components are blocked by installation in a cabinet. See your authorized Rotel dealer for information on IR repeater systems.

NOTE: The EXT REM IN jack located to the right of these jacks is for use with an external IR sensor duplicating the front panel IR sensor and located in the primary zone. It should **not** be used for ZONE 2 IR connections.

On-Screen Display / Configuration

The RSP-976 features two on-screen systems to help operate the system. The first consists of simple status displays that appear on the TV screen whenever primary settings (Volume, Input, etc.) are changed. These status displays are self-explanatory.

A more comprehensive ON-SCREEN DISPLAY menu system is available at any time by pressing the MENU button on the remote control. These menus guide you through the setup and operation of the RSP-976.

Navigation Buttons **C** **K** **L** **M**

The following remote control buttons are used to navigate the ON-SCREEN DISPLAY menu system:

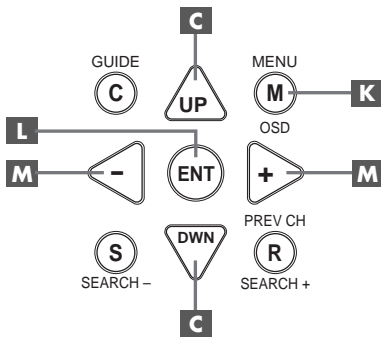

MENU Button **K:** To display the MAIN screen. All other menus are reached from this menu. If a menu is already visible, push this button to cancel the display.

DOWN/UP Buttons **C:** To move up and down in the lists that appear on the ON-SCREEN DISPLAY menu system.

+/- Buttons **M:** To change the current settings for a selected menu choice on some menus in the ON-SCREEN DISPLAY menu system.

ENTER Button **L:** To confirm a setting and return to the MAIN menu.

NOTE: A help system at the bottom of each ON-SCREEN DISPLAY menu reminds you which buttons to press.

Figure 6 at the front of this manual shows all of the menus in the ON-SCREEN DISPLAY system and how to reach them. Most menus are used only to configure the system and not typically during normal operation.

SYSTEM STATUS Menu

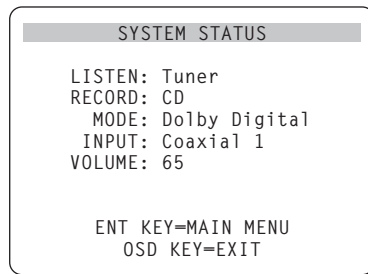

The SYSTEM STATUS menu provides a snapshot of the current system settings and a starting point for reaching all other screens and menus. This screen appears when you press the MENU button on the remote control and displays the following information:

LISTEN: the source selected for listening.

RECORD: the source selected for the VIDEO outputs.

MODE: the current surround sound mode.

INPUT: the input selected for the current source: Optical, Coaxial, Analog, etc.

VOLUME: the current volume setting.

No changes can be made using this screen; it only provides information. To go to the rest of the menus, press the ENTER button to go to the MAIN menu. Press the MENU key on the remote to cancel the display and return to normal operation.

MAIN Menu

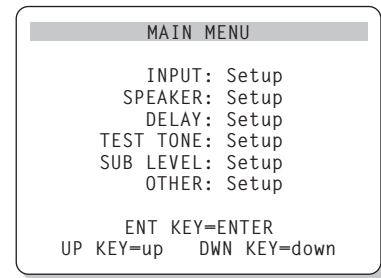

The MAIN menu provides access to all other screens and menus and is reached by pressing the ENTER button from the SYSTEM STATUS menu described above or from most other menus. To go to another menu, move the highlight to the desired line using the UP/DOWN buttons on the remote and press the ENTER button. Press the MENU key on the remote to cancel the display and return to normal operation.

INPUT Menu

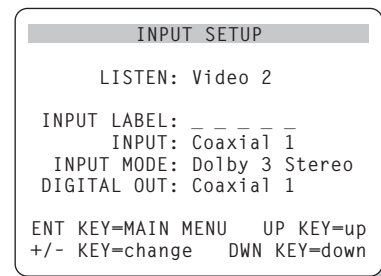

The INPUT menu configures the source inputs and is reached from the MAIN menu. The screen provides the following options, selected by placing the highlight on the desired line using the UP/DOWN buttons:

LISTEN: changes the current listening input source

INPUT LABEL: The labels for the five VIDEO inputs can be customized. This is not available for the TUNER, CD, and TAPE inputs. Place the highlight on this line to call up a sub-menu that allows you to change the five-character label for the current VIDEO source. To change the label:

1. Press the +/- keys to begin labeling.
2. Press the +/- keys to change the first letter, scrolling through the list of available characters.
3. Press the ENT key to confirm that letter and move to the next position.
4. Repeat steps 2 and 3 until all five characters have been completed. The final press of the ENT button will save the new label and exit the sub-menu.

INPUT: selects which physical input connection to use as the default for the source displayed in the first line of the menu. The options include the ANALOG inputs, the two OPTICAL digital inputs (OPTICAL 1 & 2), and the three COAXIAL digital inputs (COAXIAL 1 – 3). When a digital input is configured in this menu, the unit will check for a digital signal each time that input source button is pressed. If no digital signal is present, the unit will automatically revert to the analog input. This digital auto-sensing is the preferred configuration for digital source inputs such as DVD players.

INPUT MODE: selects the default surround sound mode for the input shown at the top of the menu. The default setting can be overridden at any time with the front-panel MODE buttons. Options include: DTS, Dolby Digital, Dolby Pro Logic, Dolby 3-Stereo, Music 1, Music 2, Music 3, Music 4, and Dolby Digital 2-ch Stereo. This is a default setting and can be manually overridden by the front panel switches MODE switches.

DIGITAL OUT: selects which digital input signal is available for recording at the digital output connectors. It is a global setting: the selected digital input will always be available at the digital outputs, regardless of which source is selected for listening. The same signal will be available at both the coaxial and optical outputs.

NOTE: We suggest that you return to this menu after connecting each source component to properly configure that source.

SPEAKER SETUP Menu

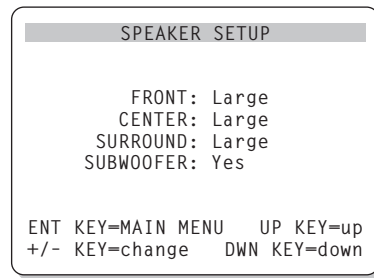

The SPEAKER SETUP menu is used to configure the RSP-976 for use with your specific loudspeakers. The menu is accessed from the MAIN menu.

Home theater speaker systems vary in their size and performance, particularly in bass output. Surround sound processors feature steering logic which sends bass information to the speaker(s) best able to handle it – subwoofers and/or large speakers. For optimum performance, you must tell the RSP-976 what types of speakers are in your system.

The following configuration instructions refer to LARGE and SMALL speakers, referring more to their bass performance than physical size. A full-range speaker with extended bass response is considered LARGE. A compact speaker with limited bass response or power handling is considered SMALL.

As a general rule, the system will redirect bass information away from SMALL speakers and send it to the LARGE speakers and/or the SUBWOOFER in your system.

Things become more complex with a subwoofer. For example, the system will generally not redirect bass information away from a LARGE speaker to the subwoofer. Thus, you must decide if you want a particular speaker to play the deep bass or whether the deep bass should be sent to the subwoofer. If you have a subwoofer, you might decide to send all of the bass to it, regardless of how capable the other speakers in the system may be. In this case, you would tell the RSP-976 that all of your speakers are SMALL, without regard to how big they may actually be.

An alternative configuration for setting up front SMALL speakers with a subwoofer is to follow the speaker manufacturer's instructions, wiring the SMALL speakers to the subwoofer's crossover and then connecting the subwoofer directly to the front speaker connection termi-

nals. In this arrangement, the speakers would be classified as LARGE and the subwoofer setting would be OFF for all surround modes. No information will be lost during playback because the system knows to redirect the bass information to the front LARGE speakers. This configuration may improve the way the bass integrates into the listening room and ensure correct satellite speaker operation by using the speaker manufacturer's own crossovers.

The following speaker options are available:

FRONT SPEAKERS (small/large): This menu setting determines what kind of main front left and right speakers you are using. Use the LARGE setting if your main left and right speakers are full range designs with good bass response capability. If you are using minispeakers, use the SMALL setting.

CENTER SPEAKER (small/large/none): Use the LARGE position (not available with SMALL front speakers) if your system's center channel speaker is capable of full-range, extended bass response. Use the SMALL position if your center channel speaker has more limited low frequency capability, or if you prefer that the bass be sent to the subwoofer. Select the NONE setting if your system does not have a center channel speaker.

REAR SPEAKERS (small/large/none): If your rear surround speakers are capable of sustained low frequency output, select the LARGE setting (not available with SMALL front speakers). If your rear speakers have limited bass capability or if you would prefer that the bass go to a subwoofer, use the SMALL setting. If your system has no rear surround speakers, select the NONE setting (surround information will be added to the front speakers).

SUBWOOFER (yes/no): Use the YES setting if your system has a subwoofer. If your system does not have a subwoofer, select NO.

NOTE: Speaker configuration is a global setting for all surround modes and need only be done once.

To change a setting, place the highlight on the desired line using the UP/DOWN buttons and use the +/- buttons to toggle through the available settings. To return to the MAIN menu, press the ENTER button. Press the MENU key on the remote to cancel the display and return to normal operation.

DELAY SETUP Menu

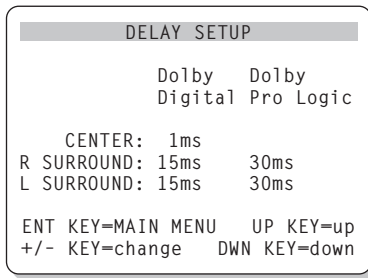

This menu, which is reached from the MAIN menu, allows you to set the delay for individual speakers. This ensures that the sound from each speaker arrives simultaneously at the listening position, even when the speakers not all placed at equal distances from the listener.

Although personal preference is the ultimate guide, you typically increase the delay to speakers located closer to the seating area and decrease the delay to speakers located farther from the seating area.

Start by measuring the distance from your seating position to each speaker. The speaker farthest away should receive no additional delay. Each of the other speakers will receive one millisecond of delay for each foot (30 cm) closer to you than the farthest speaker. For example, if the left front speaker is farthest away at 13 feet and the left rear speaker is 8 feet away, you should add 5 milliseconds of delay to the left rear speaker. Continue setting delays for each speaker until you have compensated for each speaker that is closer to you than the farthest speaker.

The delay times for the surround speakers are set longer for Dolby Pro Logic mode than in Dolby Digital mode. When you change delay setting for Dolby Digital, the delay time for Dolby Pro Logic will automatically be set 15ms longer.

The available settings for the CENTER channel (Dolby Digital only) are 0ms, 1ms, 2ms, 3ms, 4ms, and 5ms. For SURROUND (Dolby Digital), the settings are 0ms, 5ms, 10ms, and 15ms. For SURROUND (Dolby Pro Logic), the settings are 15ms, 20ms, 25ms, and 30ms.

To change a setting, place the highlight on the desired line using the UP/DOWN buttons and use the +/- buttons to increase or decrease the delay setting. To return to the MAIN menu, press the ENTER button. Press the MENU key on the remote to cancel the display and return to normal operation.

SUBWOOFER LEVEL Menu

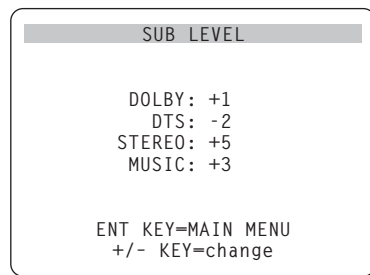

The SUBWOOFER LEVEL menu provides independent adjustment of subwoofer level for each surround mode. These settings are memorized and engaged automatically each time a music or theater surround mode is selected.

When going to the SUBWOOFER LEVEL menu from the MAIN menu, the current surround mode is automatically highlighted.

NOTE: Only the current surround mode can be adjusted on this menu. You will need to change surround modes using the front panel or remote buttons to adjust a different mode.

Use the +/- buttons to adjust the subwoofer level for the current surround mode. To return to the MAIN menu, press the ENTER button. Press the MENU key on the remote to cancel the display and return to normal operation.

TEST TONE Menu

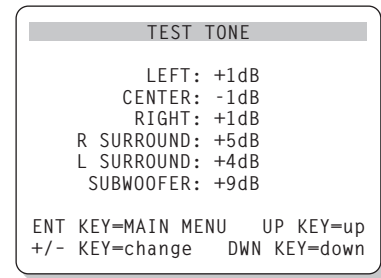

This menu uses test tones to set equal volume levels for all speakers (left front, center, right front, right surround, left surround, and subwoofer) to ensure proper surround sound reproduction. Setting the output levels using the test procedure provides the most accurate adjustment so that digital surround sound material will be reproduced as it was intended.

To access this menu and perform the test tone calibration, you must be in one of the surround modes. To do this, press any of the MODE buttons except 2CH. Then, enter the ON-SCREEN DISPLAY menu system and select TEST TONE from the MAIN menu to reach this screen.

When you enter the TEST TONE menu, you will hear a test tone coming from the highlighted speaker. Highlight different speakers by moving the cursor to the desired line using the UP/DOWN buttons. The test tone will shift accordingly to the selected speaker.

While seated in the normal listening location, switch the test tone to the various speakers. Using the loudest speaker as a fixed reference, listen to hear if any other speakers are noticeably louder or quieter. If so, adjust that speaker's volume levels up or down (in 1 dB increments) to match using the +/- buttons. Continue switching among the speakers and adjusting until all speakers are the same volume.

NOTE: This calibration will be more accurate using a sound pressure level (SPL) meter instead of relying on your ear. Set the meter to its SLOW response time with C-weighting and hold it away from your body. Adjust the levels until the meter provides the same reading for each of the speakers in your system.

To return to the MAIN menu, press the ENTER button. Press the MENU key on the remote to cancel the menu display and return to normal operation.

OTHER OPTIONS Menu

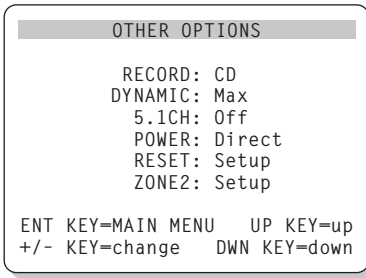

This menu, accessed from the MAIN menu, provides access to a several miscellaneous settings as follows:

RECORD: Select a signal for the record outputs by choosing one of the input sources.

DYNAMIC: steps through the three dynamic range settings available in digital modes:

- MAX (no compression/full dynamic range)
- MID (moderate compression)
- MIN (full compression/minimum dynamic range).

5.1CH: determines whether or 5.1 channel input is turned ON or OFF.

POWER: This setting determines how the RSP-976 powers up. With the default DIRECT setting, the unit is fully activated when AC power is applied; however, it may be put in STANDBY mode using the front panel STANDBY or remote POWER button. With the STANDBY setting, the unit powers up in standby mode when AC is applied and must be activated from the front-panel or remote control. In ALWAYS-ON mode, the unit remains fully active whenever AC is present; the front panel and remote STANDBY or POWER buttons are disabled.

RESET: Place the highlight on this line and press the ENTER button to call a submenu (described in the next section) to reset all settings to their factory defaults.

ZONE 2: Place the highlight on this line and press the ENTER button to call the ZONE 2 MENU for configuring Zone 2 operation.

Change settings on the OTHER OPTIONS menu by highlighting the desired line using the UP/DOWN buttons and using the +/- buttons to step through the available settings. To return to the MAIN menu, press the ENTER button. Press the MENU key on the remote to cancel the display and return to normal operation.

RESET Menu

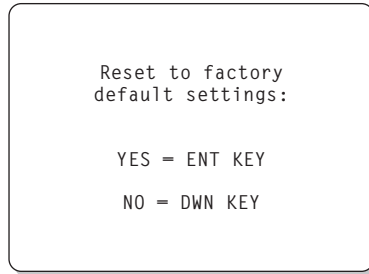

The FACTORY DEFAULT menu resets all system configuration settings to the factory supplied settings. This menu is reached by highlighting the RESET line on the OTHER OPTIONS menu and pressing ENTER.

Press the ENTER button to reset all settings. Press the DOWN button to cancel this menu and return to the OTHER OPTIONS menu without restoring the default settings.

NOTE: *Resetting to factory default settings will erase all stored settings including delay settings, speaker settings, balance settings, input settings and more. You will lose ALL system configuration settings. Be certain that you wish to do so before resetting the factory defaults.*

ZONE 2 SETUP Menu

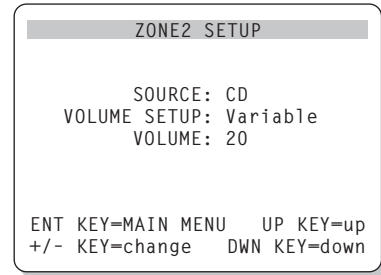

The ZONE 2 SETUP menu provides settings and configuration options related to the operation of Zone 2. This menu is reached by highlighting the ZONE 2 line on the OTHER OPTIONS menu and pressing ENTER.

SOURCE: the source selected for listening in Zone 2. Selecting the OFF option turns Zone 2 off.

VOLUME SETUP: configures the Zone 2 outputs for VARIABLE or FIXED volume levels. VARIABLE allows control of the volume settings in Zone 2 from the RSP-976 front panel or from a remote control and IR repeater in Zone 2. FIXED output disables the Zone 2 volume control. In this mode, the Zone 2 level can be fixed at the level specified on the next line, thus optimizing system performance when sending a fixed level signal to a preamp or amplifier with its own volume adjustment.

VOLUME: In VARIABLE output mode, this line shows the current volume setting for Zone 2. In FIXED output mode, this use this setting to establish a permanent fixed output level for Zone 2.

Move the highlight to the desired line using the UP/DOWN buttons and use the +/- buttons to adjust the volume level. To return to the MAIN menu, press the ENTER button. Press the MENU key on the remote to cancel the display and return to normal operation.

Specifications

Audio

Total Harmonic Distortion:

<0.03%

Intermodulation Distortion (60 Hz: 7 kHz):

<0.03%

Frequency Response:

10 Hz - 20 kHz, ± 1 dB (line level)

10 Hz - 20 kHz, ± 0.3 dB (digital level)

Signal to Noise Ratio (IHF A-weighted):

92 dB (Stereo) Analog

90 dB (Dolby Digital, dts) OdBFs

Input Sensitivity/Impedance:

Line Level: 200 mV/47 kohms

Tone Controls (Bass/Treble):

± 8 dB at 100 Hz/10 kHz

Line Output Level:

600 mV (200 mV Input)

Video

Frequency Response:

3 Hz-10 MHz, ± 3 dB

Signal to Noise Ratio:

45 dB

Input Impedance:

75 ohms

Output Impedance:

75 ohms

Output Level:

1 volt

General

Power Consumption:

40 watts

Power Requirements (AC):

115 volts, 60Hz (USA)

230 volts, 50Hz (Europe)

Weight:

6.9 Kg/15.2 lb.

Dimensions (W x H x D):

440 x 121 x 303 mm

17 $\frac{3}{8}$ " x 4 $\frac{7}{8}$ " x 12"

All specifications are accurate at the time of printing.

Rotel reserves the right to make improvements without notice.

Rotel and the Rotel HiFi logo are registered trademarks of The Rotel Co, Ltd., Tokyo, Japan.

DTS is a registered trademark of Digital Theater Systems.

Manufactured under license from Dolby Laboratories Licensing Corporation. "Dolby", "Pro Logic", and the double-D symbol are trademarks of Dolby Laboratories Licensing Corporation. Confidential unpublished works © 1992 - 1997 Dolby Laboratories, Inc. All rights reserved.

ROTEL®

The Rotel Co. Ltd.

10-10 Shinsen-Cho
Shibuya-Ku
Tokyo 150-0045
Japan
Phone: +81 3-5458-5325
Fax: +81 3-5458-5310

Rotel of America

54 Concord Street
North Reading, MA 01864-2699
USA
Phone: +1 978-664-3820
Fax: +1 978-664-4109

Rotel Europe

Meadow Road
Worthing, West Sussex BN11 2RX
England
Phone: +44 (0)1903 524 813
Fax: +44 (0)1903 524 831

Rotel Deutschland

Kleine Heide 12
D-33790 Halle/Westf.
Germany
Phone: +49 05201-87170
Fax: +49 05201-73370

www.rotel.com