

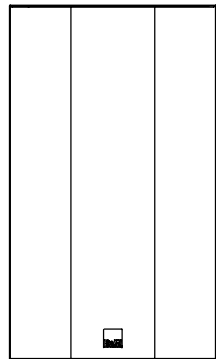

GRILLE OFF

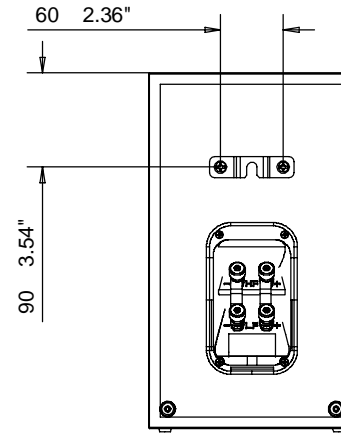

GRILLE ON

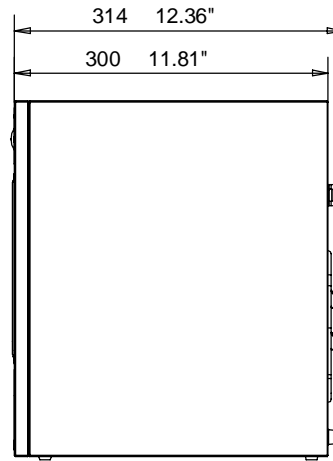
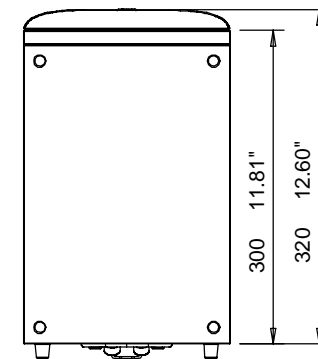
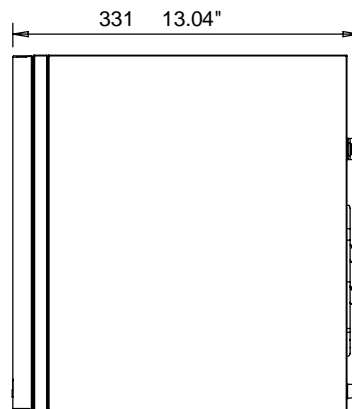

ALL COMPONENTS MUST BE RoHS COMPLIANT

 DO NOT SCALE  Bowers & Wilkins	DIMENSIONS IN mm	
	TOLERANCES	
	0.	± 0.5
	0,0	± 0.3
	0,00	± 0.1
ANGLES ± 0.5°		
UNLESS OTHERWISE STATED		

MATERIAL	
FINISH	

ISS	AMENDMENT	ECN NO.	DATE	APPROVAL
2 DRAWING UPDATED FOR LATEST COMPONENTS		PDC2500	23.11.06	
TITLE				
685 LINE DRAWING				

COPYRIGHT © 2006		PART NO.	
DRAWN SM	DATE 12.9.06	FP25959	
CHECKED / APPROVED MC	MC	DRG. NO.	ISS
SCALE 1:5		A8287-1-1	(2)
FULL DRG SIZE A3			