

Bowers & Wilkins

CM9 S2

LEFT SIDE

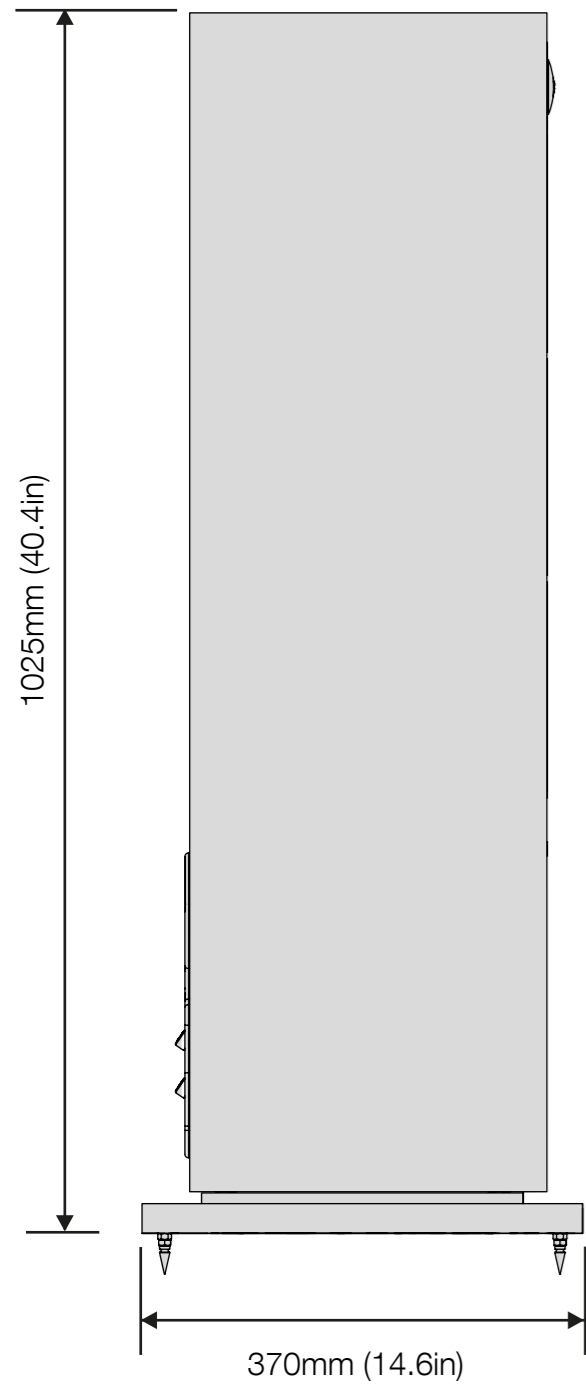

FRONT

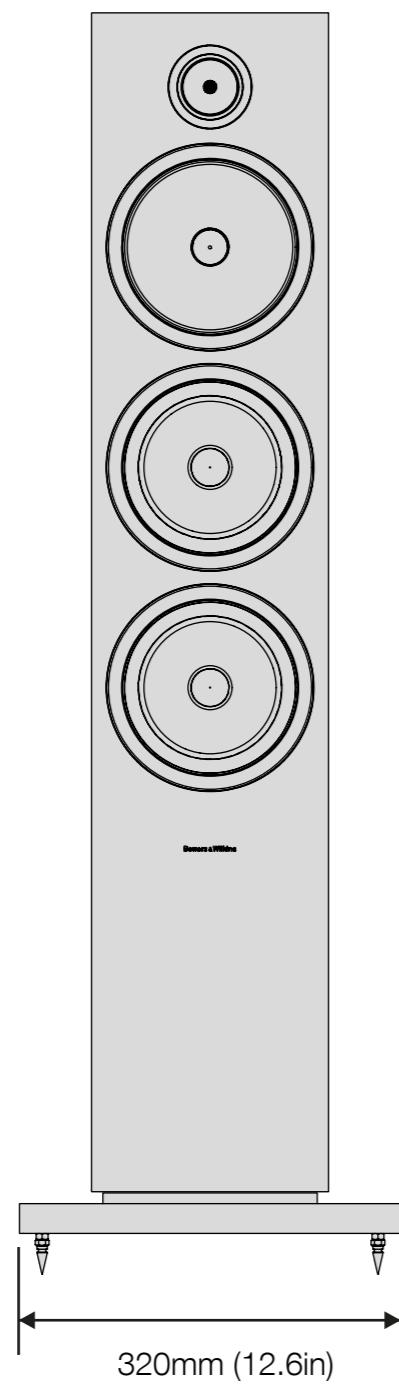

RIGHT SIDE

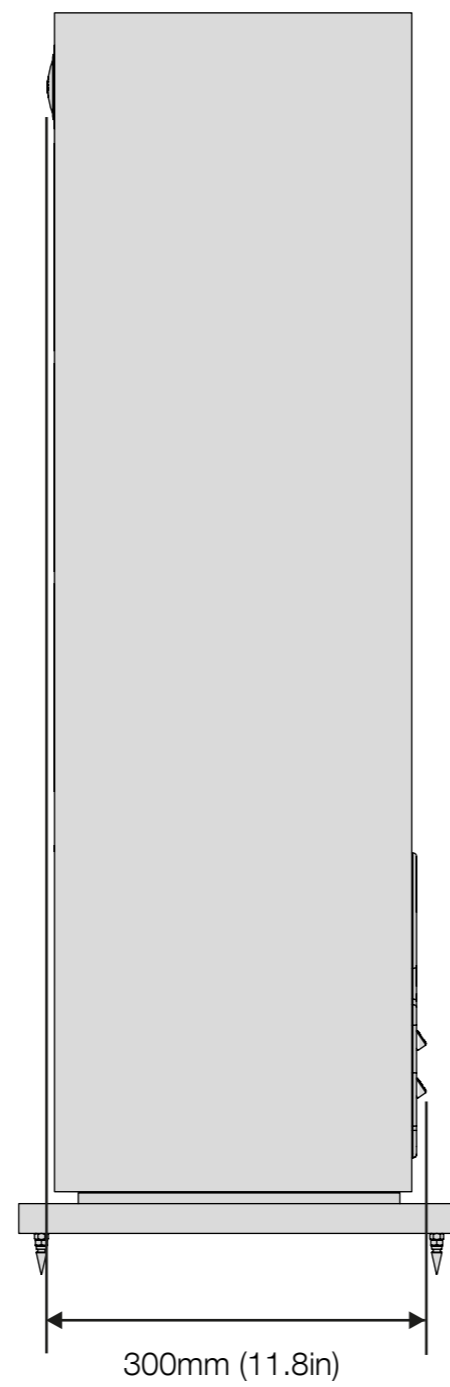

BACK

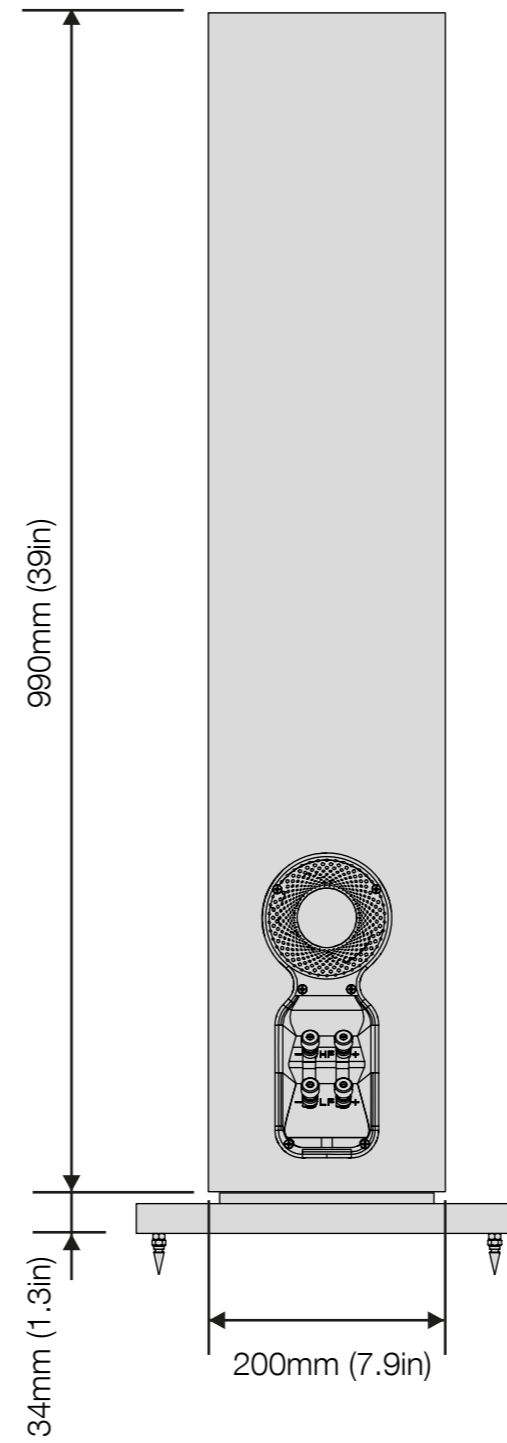

TOP

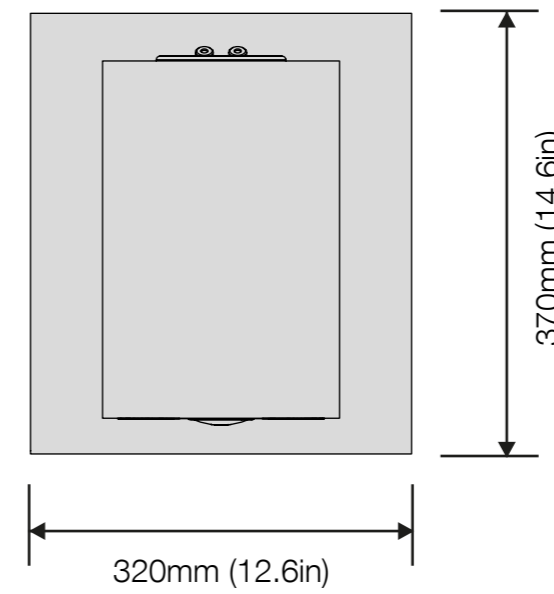

BASE
SCREW ALIGNMENT FOR PLINTH

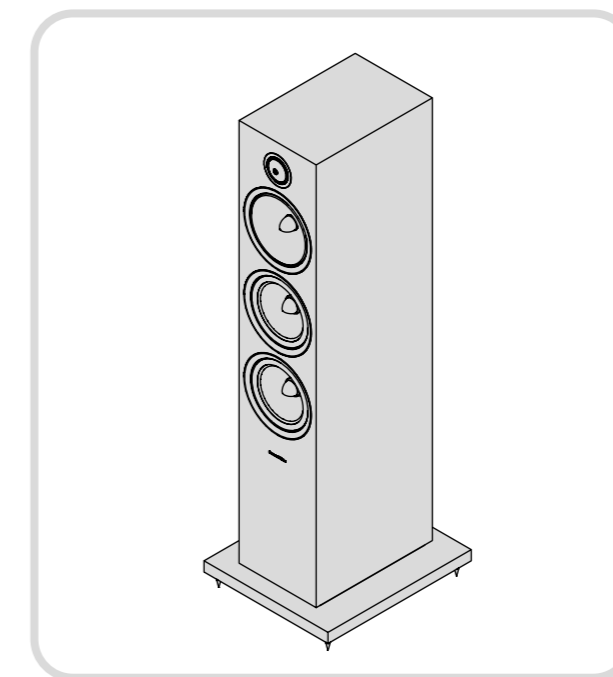
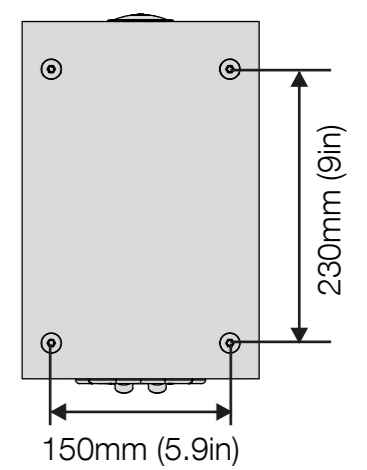

PLINTH BASE
SCREW AND FOOT ALIGNMENT

