

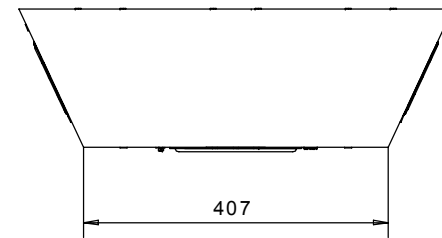

GRILLE OFF

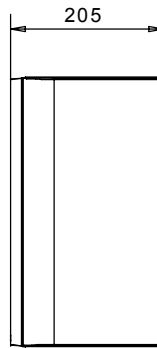
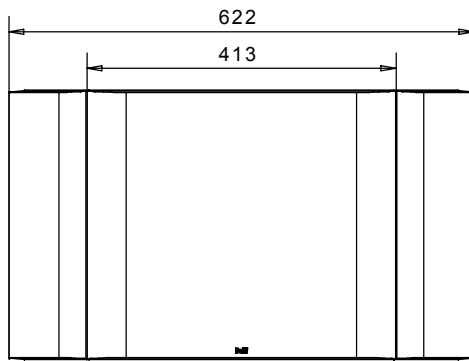
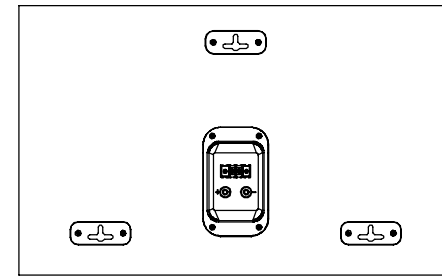
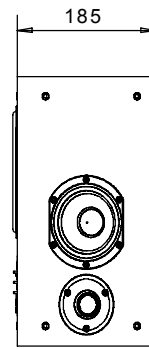
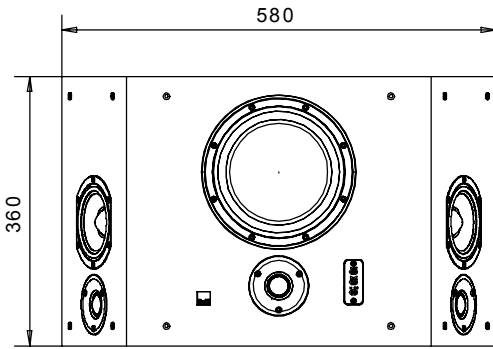
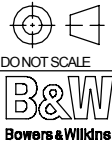

GRILLE ON

 <p><b>B&amp;W</b> Bowers &amp; Wilkins</p>	<p>DIMENSIONS IN mm</p> <p><b>TOLERANCES</b></p> <p>0. ± 0.5</p> <p>0.0 ± 0.3</p> <p>0.00 ± 0.1</p> <p>ANGLES ± 0.5°</p> <p>UNLESS OTHERWISE STATED</p>	<p>MATERIAL</p> <p>FINISH</p>	<p>2 REDRAWN</p>				<p>COPYRIGHT © 2004</p>		<p>PART NO.</p>			
			<p>ISS</p>		<p>AMENDMENT</p>		<p>ECN NO.</p>		<p>DATE</p>		<p>APPROVAL</p>	
<p>TITLE</p> <p><b>DS8S LINE DRAWING</b></p>			<p>22.6.05</p>				<p>CHECKED / APPROVED</p>		<p>DATE</p> <p>30.09.04</p>		<p>FP16985</p>	
<p>UNLESS OTHERWISE STATED</p>			<p>SCALE</p> <p>NTS</p>				<p>FULL DRG SIZE</p> <p>A3</p>		<p>DRG. NO.</p> <p>A7082-1-1</p>		<p>ISS</p> <p>(2)</p>	